

The new wedi Fundo Riolito^{neo}

Even more flexibility

Extension of the Fundo Riolito product range

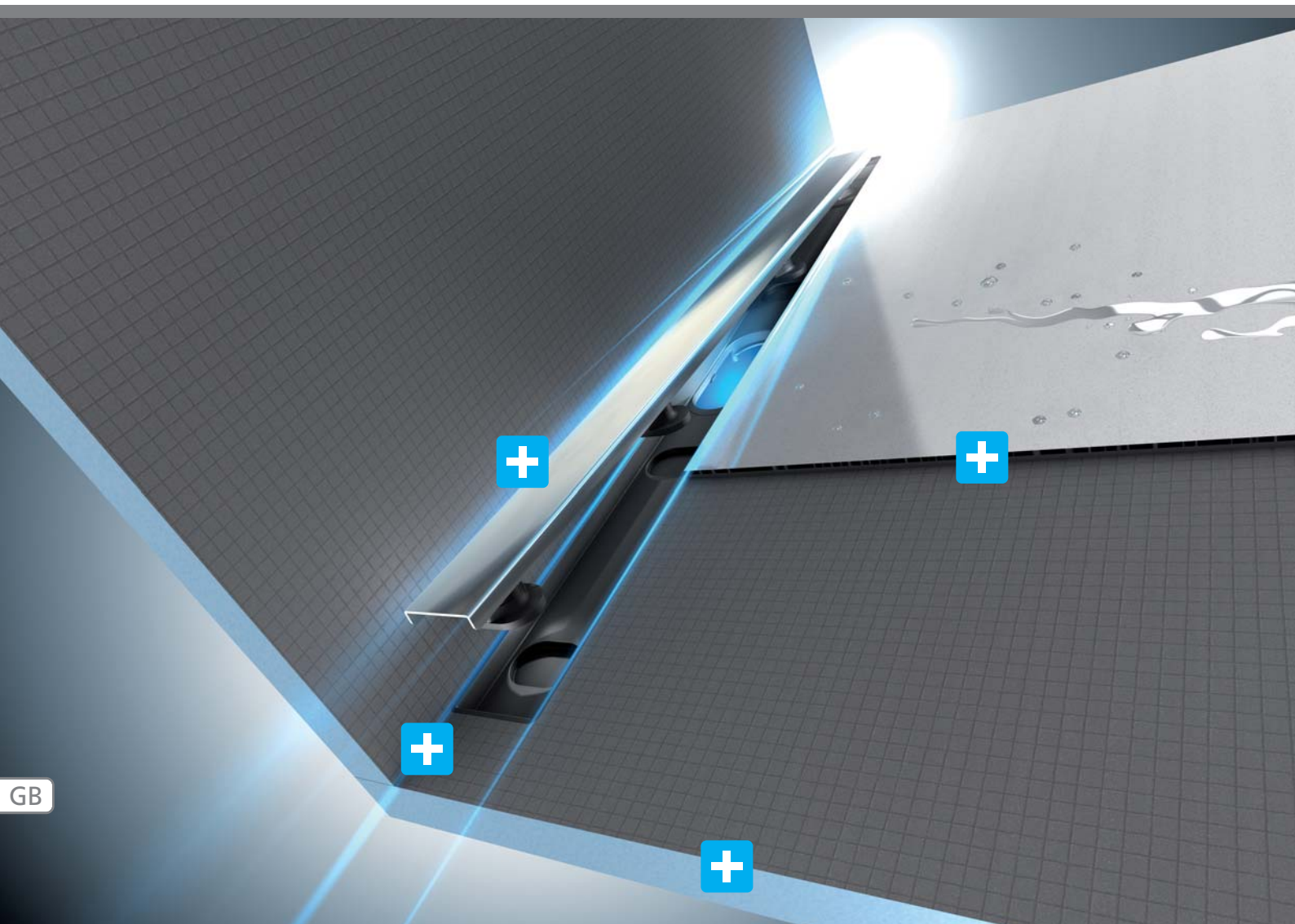

Small changes, **great performance**



High-quality channel cover
– now flush against the wall



The use of large tiles
with fewer joints

One single slope running
up to the channel drain





The new **wedi Fundo Riolito^{neo}**

The particular added value of the new Fundo Riolito^{neo}

Thanks to a new, slimmer, oval drain the channel drain for the new Fundo Riolito^{neo} can be located even closer to the wall. Also in this case, large format tiles can be laid almost seamlessly.

Height adjustment for the channel is integrated directly into the channel cover. A new development which, among other things, makes cleaning easier.

In addition, installation of the new Fundo Riolito^{neo} is just as easy and safe as the installation of the original Fundo Riolito range.

The new wedi Fundo Riolito^{neo} – Innovation with added value.

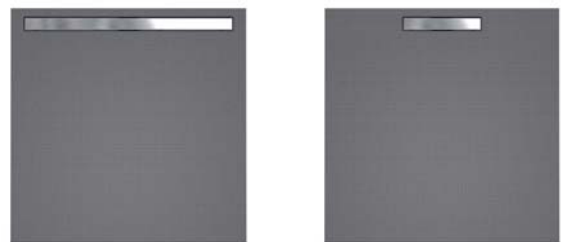

Many versions with long and now with short drain channels



Continuous single slope – ideal for large tiles



Channel cover with integrated height adjustment



New and multiple waste options with up to 67.2 l/min

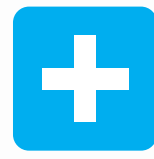
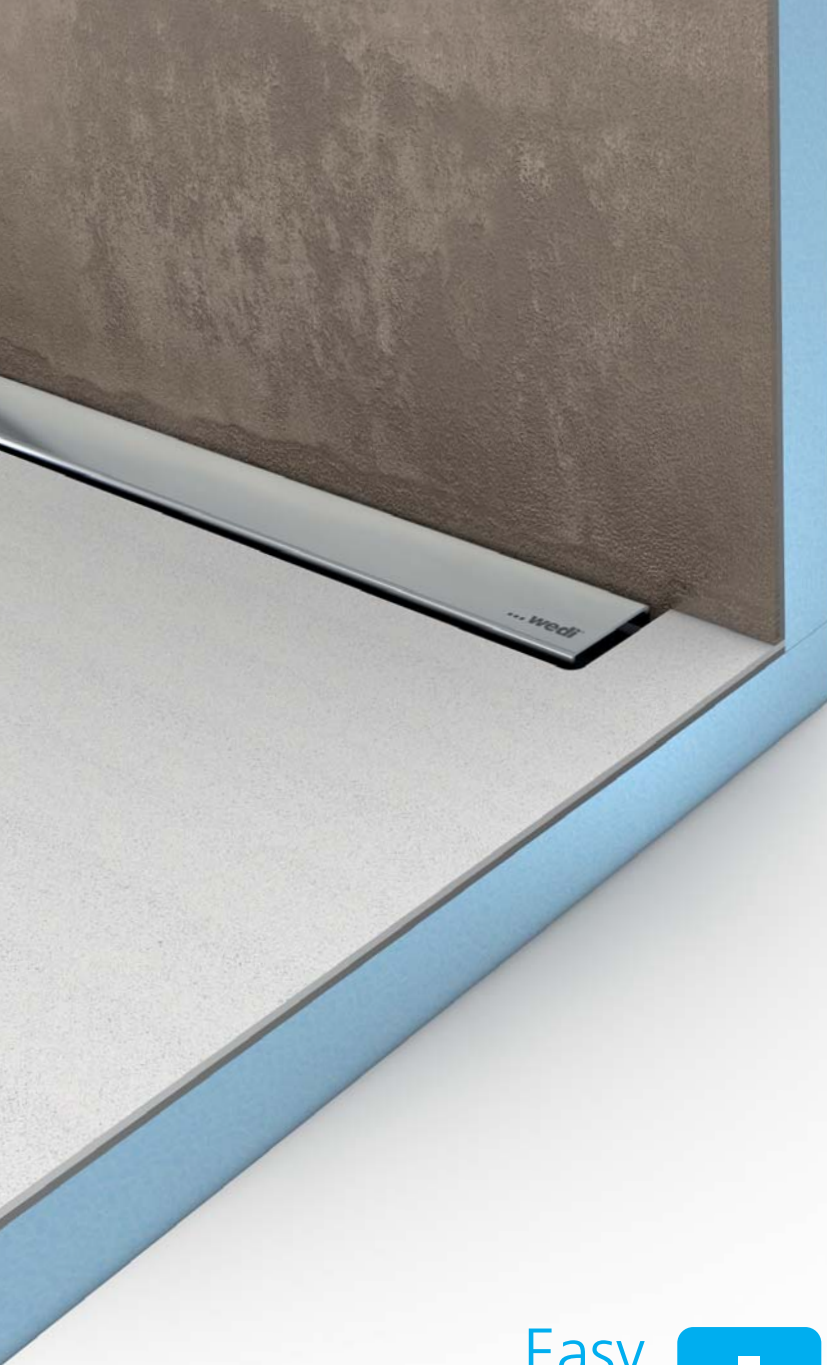

New Design

The new Fundo Riolito^{neo} is now equipped with the drain positioned closer to the wall as requested by customers.

- + Optical highlight in any bathroom
- + Large tiles with fewer joints
- + Also available with short drainage channel
- + Elegant channel covers with an integrated height adjusting system

Easy to use



The already convenient handling of Fundo Riolito has been simplified even further for Fundo Riolito^{neo}.

- + Highly flexible when it comes to cutting the format to size especially when using the shorter channel version
- + Practical positioning aids for installing is included in the scope of delivery
- + System expansion in the form of sloping boards, suitable for Fundo Riolito and Fundo Riolito^{neo}
- + Elimination of upward gradients





Wide range of **Functions**

Numerous format versions with long and short channels.

- + 10 new sizes available to suit any installation situation
- + Versatile drain selections for different situations
- + Greater height adjustment in wedi Fundo Riolito^{neo} channel covers – from 5 to 25 mm
- + Height adjustment integrated into the channel cover, e.g. for easy cleaning
- + Full profile systems available to offer a luxury finish

Added values: **POS-Support**

Informative and customer-oriented multichannel sales support!

- + Modern packaging design with QR Code with all relevant information
- + Illustrated installation instructions with easy-to-understand explanations of each step
- + wedi YouTube channel with over 90 practical installation videos
- + Numerous brochures adapted to the needs of the customer (retail, professionals...)



The **wedi System**

Functions!

wedi Fundo Riolito Discreto The well-known wedi Fundo Riolito Discreto, the flexible and attractive wall drain, easily and safely combined with the new floor element wedi Fundo Riolito^{neo}.

You also have the possibility of creating benches, a lining or a shelf.



Design!

wedi Fundo Profiles The corresponding finish and slope profiles are of course also available for the new wedi Fundo Riolito^{neo}.

Top-class bonding on all sides continues to mean an aesthetically-pleasing transition from the floor element to the side wall, to the adjacent tiled floor as well as above the linear drainage to the front side of the wall.

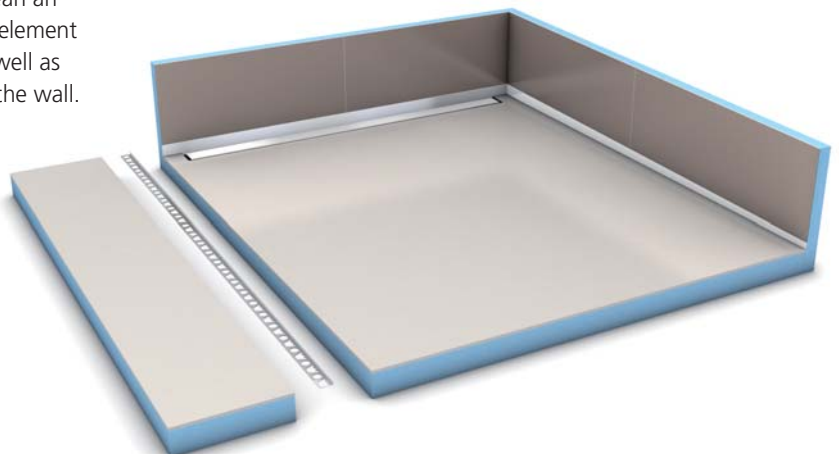

Variants!

wedi Fundo Riolito^{neo} with a short or long channel option The new Fundo Riolito^{neo} is available not only in multiple formats, but also has the option of short or long channel drains.

The shorter channel drain gives more flexibility on site to cut the floor elements to a individual customized size.

Whichever version you decide on, you can depend 100% on the unique advantages of this system with the right drains and full profile system customized to the drain.

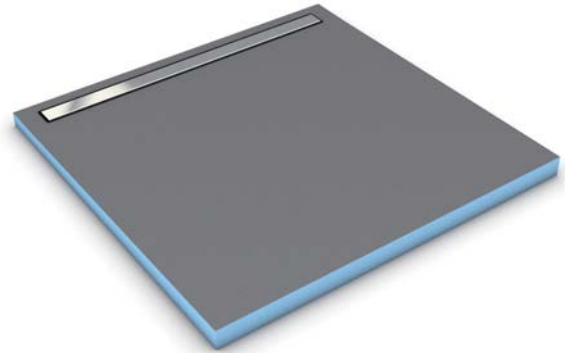

More Options!

Systematic and complete For more than 30 years, wedi customers have trusted the premium quality of modular product systems.

wedi floor-level trays, boards, made to measure or custom made elements can all be combined together. Thanks to the comprehensive installation notices. The endresult is the tried-and-tested system with the level of quality and guarantee that you have come to expect from wedi.

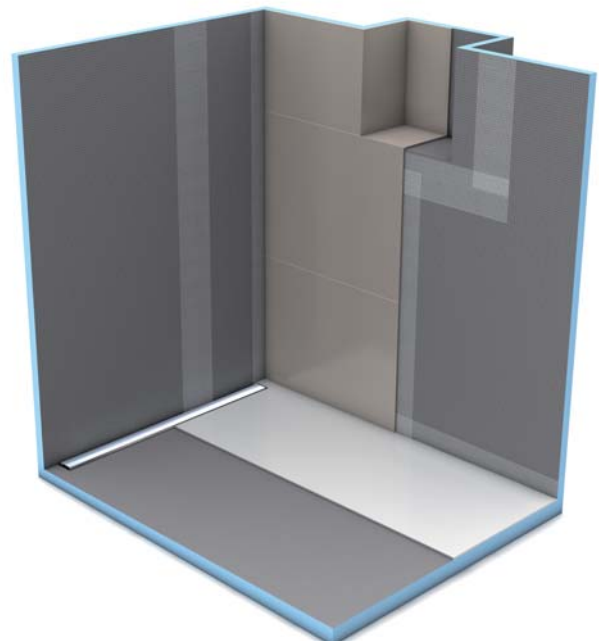

Technical properties

Technical properties – Fundo Riolito^{neo}

Wheelchair load-bearing from minimum tile size	50 x 50 mm
Glass mosaic from minimum size	20 x 20 mm
Minimum foundation height depending on the drain:	
horizontal drain, DN 50	130 mm
vertical drain, DN 50	50 mm
horizontal drain, Mini Max, DN 40	97 mm

For impact sound deadening floor structures, the installation of impact sound deadening under wedi Fundo and edge insulating strips should be planned: Design using the wedi impact sound deadening Nonstep Plan. Alternatively, approved polythene membranes can be used.

wedi Fundo Riolito^{neo} floor elements can be shortened on site, but the geometry of the elements must be maintained.

Technical properties – Floor element

Material	XPS
Long-term compressive strength (50 years) \leq 2% compression EN 1606	0.08 N/mm ²
Compressive resistance at 10% compression EN 826	0.25 N/mm ²
Thermal conductivity EN 13164	0.036 W/mK
Bulk density EN 1602	32 kg/m ³
Temperature limits	-50°C / +75°C
Fire behaviour EN 13501-1	E
Waterproof tested to	1.5 bar

Technical properties – Drain

Sealed, built-in drainage channel with drain base and odour trap. Channel cover can be adapted to tile size.

The Fundo Riolito ^{neo} is available with channels in the following lengths:	300 mm/40 mm
	700 mm/40 mm
	800 mm/40 mm
	900 mm/40 mm
	1100 mm/40 mm
Drain performance depending on the drain selected:	
Fundo Riolito ^{neo} drain, horizontal, DN 50	0.80 l/s ; 48.0 l/min
Fundo Riolito ^{neo} drain, vertical, DN 50	1.12 l/s ; 67.2 l/min
Fundo Riolito ^{neo} drain, horizontal, DN 40 Minimax	0.40 l/s ; 24 l/min

The channel covers are available in three models: standard, exclusive and tileable.

Technical properties – Channel cover

wedi Fundo Riolito ^{neo} channel cover standard	5 up to 25 mm
wedi Fundo Riolito ^{neo} channel cover exclusive	5 up to 25 mm
wedi Fundo Riolito ^{neo} channel cover tileable	5 up to 25 mm

Item numbers and designs

wedi Fundo Riolito^{neo}



Description	External dimensions: W x L x H	Channel: L	Order no.
Floor element with channel drain, rectangular	1200 x 800 x 50 mm	700 mm ①	07-51-00/001
Floor element with channel drain, rectangular	1200 x 900 x 50 mm	800 mm ②	07-51-00/004
Floor element with channel drain, rectangular	1200 x 1000 x 50 mm	900 mm ③	07-51-00/008
Floor element with channel drain, rectangular	1400 x 900 x 50 mm	700 mm ①	07-51-00/033
Floor element with channel drain, rectangular	1600 x 1000 x 50 mm	800 mm ②	07-51-00/034
Floor element with channel drain, rectangular	1800 x 900 x 60 mm	800 mm ②	07-51-00/005
Floor element with channel drain, square	900 x 900 x 50 mm	800 mm ②	07-51-00/003
Floor element with channel drain, square, with short channel	900 x 900 x 50 mm	300 mm	07-51-00/031
Floor element with channel drain, square	1000 x 1000 x 50 mm	800 mm ②	07-51-00/032
Floor element with channel drain, square	1200 x 1200 x 50 mm	1100 mm	07-51-00/010

Fundo Riolito^{neo}, square

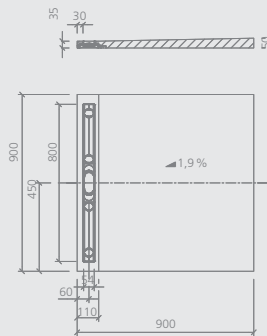

Fundo Riolito^{neo}, square, with short channel

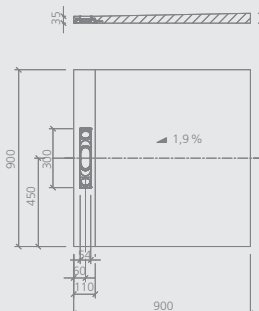

Fundo Riolito^{neo}, rectangular

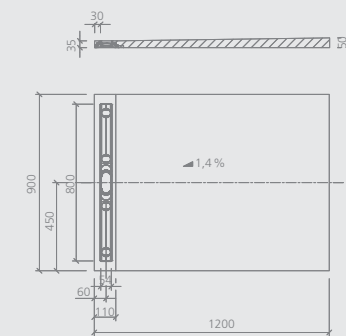

wedi Fundo Riolito Discreto



Description	Length x height x depth	Channel: L	Order no.
wedi Fundo Riolito Discreto, attachment element	800 x 180 x 76 mm	700 mm ①	07-37-38/200
wedi Fundo Riolito Discreto, attachment element	900 x 180 x 76 mm	800 mm ②	07-37-38/201
wedi Fundo Riolito Discreto, attachment element	1000 x 180 x 76 mm	900 mm ③	07-37-38/202

i • Numbers ①, ② and ③ designate the suitable combination versions with the Fundo Riolito^{neo}.

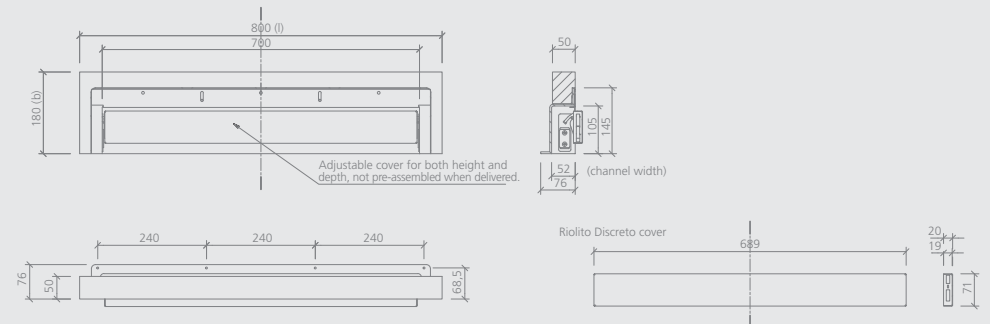

Item numbers and designs

wedi Fundo Riolito^{neo} slope profiles

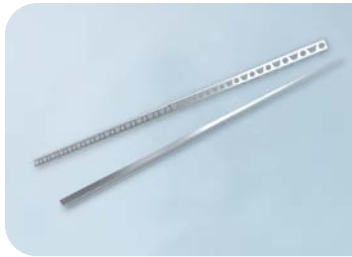

Description	Height	Length	Order no.
wedi Fundo Riolito ^{neo} slope wedge, left-hand version	8,0 mm	1200 mm	10-71-00/008
wedi Fundo Riolito ^{neo} slope wedge, left-hand version	10,0 mm	1200 mm	10-71-00/010
wedi Fundo Riolito ^{neo} slope wedge, left-hand version	12,5 mm	1200 mm	10-71-00/012
wedi Fundo Riolito ^{neo} slope wedge, left-hand version	8,0 mm	1600 mm	10-81-20/008
wedi Fundo Riolito ^{neo} slope wedge, left-hand version	10,0 mm	1600 mm	10-81-20/010
wedi Fundo Riolito ^{neo} slope wedge, left-hand version	12,5 mm	1600 mm	10-81-20/012
wedi Fundo Riolito ^{neo} slope wedge, left-hand version	8,0 mm	1800 mm	10-81-40/008
wedi Fundo Riolito ^{neo} slope wedge, left-hand version	10,0 mm	1800 mm	10-81-40/010
wedi Fundo Riolito ^{neo} slope wedge, left-hand version	12,5 mm	1800 mm	10-81-40/012
wedi Fundo Riolito ^{neo} slope wedge, right-hand version	8,0 mm	1200 mm	10-71-10/008
wedi Fundo Riolito ^{neo} slope wedge, right-hand version	10,0 mm	1200 mm	10-71-10/010
wedi Fundo Riolito ^{neo} slope wedge, right-hand version	12,5 mm	1200 mm	10-71-10/012
wedi Fundo Riolito ^{neo} slope wedge, right-hand version	8,0 mm	1600 mm	10-81-30/008
wedi Fundo Riolito ^{neo} slope wedge, right-hand version	10,0 mm	1600 mm	10-81-30/010
wedi Fundo Riolito ^{neo} slope wedge, right-hand version	12,5 mm	1600 mm	10-81-30/012
wedi Fundo Riolito ^{neo} slope wedge, right-hand version	8,0 mm	1800 mm	10-81-50/008
wedi Fundo Riolito ^{neo} slope wedge, right-hand version	10,0 mm	1800 mm	10-81-50/010
wedi Fundo Riolito ^{neo} slope wedge, right-hand version	12,5 mm	1800 mm	10-81-50/012
wedi Fundo Riolito ^{neo} slope profile wall, left-hand version	8,0 mm	1200 mm	10-72-00/008
wedi Fundo Riolito ^{neo} slope profile wall, left-hand version	10,0 mm	1200 mm	10-72-00/010
wedi Fundo Riolito ^{neo} slope profile wall, left-hand version	12,5 mm	1200 mm	10-72-00/012
wedi Fundo Riolito ^{neo} slope profile wall, left-hand version	8,0 mm	1600 mm	10-82-20/008
wedi Fundo Riolito ^{neo} slope profile wall, left-hand version	10,0 mm	1600 mm	10-82-20/010
wedi Fundo Riolito ^{neo} slope profile wall, left-hand version	12,5 mm	1600 mm	10-82-20/012
wedi Fundo Riolito ^{neo} slope profile wall, left-hand version	8,0 mm	1800 mm	10-82-40/008
wedi Fundo Riolito ^{neo} slope profile wall, left-hand version	10,0 mm	1800 mm	10-82-40/010
wedi Fundo Riolito ^{neo} slope profile wall, left-hand version	12,5 mm	1800 mm	10-82-40/012
wedi Fundo Riolito ^{neo} slope profile wall, right-hand version	8,0 mm	1200 mm	10-72-10/008
wedi Fundo Riolito ^{neo} slope profile wall, right-hand version	10,0 mm	1200 mm	10-72-10/010
wedi Fundo Riolito ^{neo} slope profile wall, right-hand version	12,5 mm	1200 mm	10-72-10/012
wedi Fundo Riolito ^{neo} slope profile wall, right-hand version	8,0 mm	1600 mm	10-82-30/008
wedi Fundo Riolito ^{neo} slope profile wall, right-hand version	10,0 mm	1600 mm	10-82-30/010
wedi Fundo Riolito ^{neo} slope profile wall, right-hand version	12,5 mm	1600 mm	10-82-30/012
wedi Fundo Riolito ^{neo} slope profile wall, right-hand version	8,0 mm	1800 mm	10-82-50/008
wedi Fundo Riolito ^{neo} slope profile wall, right-hand version	10,0 mm	1800 mm	10-82-50/010
wedi Fundo Riolito ^{neo} slope profile wall, right-hand version	12,5 mm	1800 mm	10-82-50/012

i • The slope profiles can be individually shortened (length: 1600 mm by max. 400 mm, all other lengths by 300 mm).

wedi Fundo Riolito^{neo} slope wedge, right-hand version

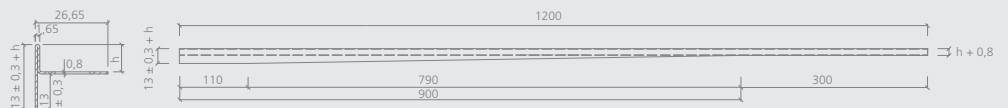

wedi Fundo Riolito^{neo} slope profile wall, left-hand version

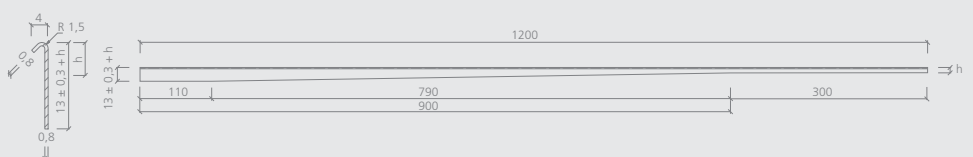

wedi Fundo Riolito^{neo} end profile



Description	Height	Length	Order no.
wedi Fundo Riolito ^{neo} end profile	21,0 mm	1000 mm	10-73-00/001
wedi Fundo Riolito ^{neo} end profile	21,0 mm	1200 mm	10-81-00/001

wedi Fundo Riolito^{neo} end profile

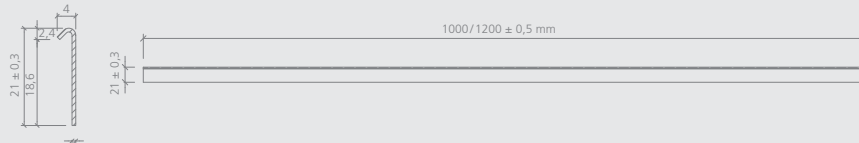









wedi Fundo Riolito^{neo} channel covers



Description	for channel lengths	Order no.
wedi Fundo Riolito ^{neo} channel cover standard, stainless steel	300 mm	67-68-00/010
wedi Fundo Riolito ^{neo} channel cover standard, stainless steel	700 mm	67-68-00/009
wedi Fundo Riolito ^{neo} channel cover standard, stainless steel	800 mm	67-68-00/008
wedi Fundo Riolito ^{neo} channel cover standard, stainless steel	900 mm	67-68-00/007
wedi Fundo Riolito ^{neo} channel cover standard, stainless steel	1100 mm	67-68-00/006
wedi Fundo Riolito ^{neo} channel cover exclusive, stainless steel	300 mm	67-68-00/001
wedi Fundo Riolito ^{neo} channel cover exclusive, stainless steel	700 mm	67-68-00/002
wedi Fundo Riolito ^{neo} channel cover exclusive, stainless steel	800 mm	67-68-00/003
wedi Fundo Riolito ^{neo} channel cover exclusive, stainless steel	900 mm	67-68-00/004
wedi Fundo Riolito ^{neo} channel cover exclusive, stainless steel	1100 mm	67-68-00/005
wedi Fundo Riolito ^{neo} channel cover tileable, stainless steel	300 mm	67-68-00/011
wedi Fundo Riolito ^{neo} channel cover tileable, stainless steel	700 mm	67-68-00/012
wedi Fundo Riolito ^{neo} channel cover tileable, stainless steel	800 mm	67-68-00/013
wedi Fundo Riolito ^{neo} channel cover tileable, stainless steel	900 mm	67-68-00/014
wedi Fundo Riolito ^{neo} channel cover tileable, stainless steel	1100 mm	67-68-00/015



-  wedi building board systems
-  wedi floor-level showers
-  wedi design elements
-  wedi sealing and decoupling

-  wedi wellness projects
-  wedi system chemistry
-  wedi practical auxiliaries
-  wedi support



wedi GmbH
Hollefeldstraße 51 · 48282 Emsdetten · Germany
Telephone +49 2572 156-0 · Fax +49 2572 156-133
info@wedi.de · www.wedi.eu

