

Fundo Shower Systems

Economical, safe and accessible!

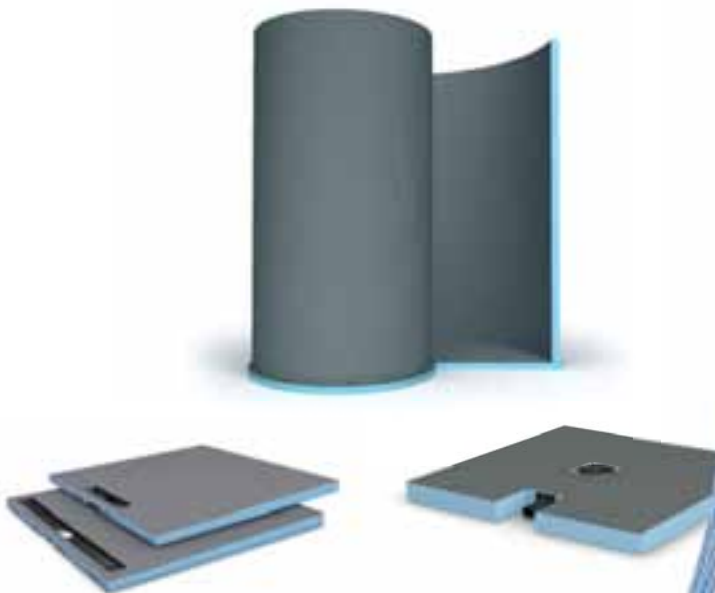

Point drainage from Page 9



wedi Fundo Primo, square, central drain

900 × 900 × 40 mm 1200 × 1200 × 40 mm
1000 × 1000 × 40 mm 1500 × 1500 × 40 mm



wedi Fundo Primo, square, corner drain

900 × 900 × 40 mm 1200 × 1200 × 40 mm
1000 × 1000 × 40 mm 1500 × 1500 × 40 mm



wedi Fundo Primo, rectangular, central drain

900 × 750 × 40 mm 1800 × 900 × 40 mm
1200 × 900 × 40 mm 1400 × 1000 × 40 mm
1400 × 900 × 40 mm 1500 × 1000 × 40 mm
1500 × 900 × 40 mm

Linear drainage from Page 15



wedi Fundo Riolito^{neo}, square, drain at the side

900 × 900 × 50 mm
1000 × 1000 × 50 mm
1200 × 1200 × 50 mm

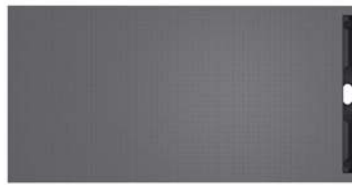

wedi Fundo Riolito^{neo}, rectangular, drain at the side

1200 × 800 × 50 mm 1800 × 900 × 60 mm
1200 × 900 × 50 mm 1600 × 1000 × 50 mm
1200 × 1000 × 50 mm
1400 × 900 × 50 mm



wedi Fundo Riolito, square, drain at the side

900 × 900 × 50 mm
1000 × 1000 × 50 mm
1200 × 1200 × 50 mm

Special solutions from Page 33

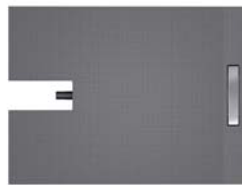

wedi Fundo Plano Linea, short channel

900 × 900 × 70 mm
1200 × 900 × 70 mm

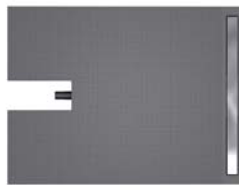

wedi Fundo Plano Linea, long channel

900 × 900 × 70 mm
1200 × 800 × 70 mm
1200 × 900 × 70 mm
1200 × 1000 × 70 mm



wedi Fundo Ligno, square, central drain

900 × 900 × 20/41 mm
1200 × 1200 × 20/41 mm
1500 × 1500 × 20/41 mm

▲ Upper side
◀ Lower side



wedi Fundo Plano, square, central drain

900 × 900 × 65 mm
1000 × 1000 × 65 mm
1200 × 1200 × 65 mm



wedi Fundo Plano, rectangular, central drain

1200 × 900 × 65 mm



wedi Fundo Plano, rectangular, central drain

1200 × 900 × 65 mm

Special formats from Page 59



wedi Fundo Nautilo, left entry

1890 × 1515 × 50 mm



wedi Fundo Nautilo, right entry

1890 × 1515 × 50 mm



wedi Fundo Trollo, central drain

Ø 1140 × 40 mm



wedi Fundo Primo, rectangular, offset drain

1200 x 900 x 40 mm
1800 x 900 x 40 mm



wedi Fundo Riolito, rectangular, drain at the side

1200 x 800 x 50 mm 1800 x 900 x 60 mm
1200 x 900 x 50 mm 1600 x 1000 x 50 mm
1200 x 1000 x 50 mm
1400 x 900 x 50 mm



wedi Fundo Riofino, square, central drain

900 x 900 x 50 mm
1000 x 1000 x 50 mm
1200 x 1200 x 50 mm



wedi Fundo Riofino, rectangular, central drain

1200 x 900 x 50 mm
1800 x 900 x 50 mm



▲ Upper side
◄ Lower side

wedi Fundo Ligno, square, corner drain

900 x 900 x 20/41 mm
1200 x 1200 x 20/41 mm

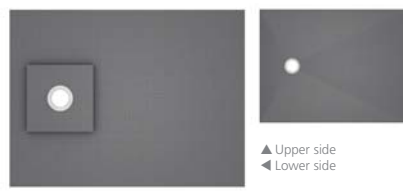

▲ Upper side
◄ Lower side

wedi Fundo Ligno, rectangular, offset drain

1200 x 900 x 20/41 mm
1600 x 900 x 20/41 mm



wedi Fundo Plano, rectangular, offset drain

1400 x 900 x 65 mm
1600 x 1000 x 65 mm



wedi Fundo Riolito Discreto attachment element

800 x 180 x 76 mm
900 x 180 x 76 mm
1000 x 180 x 76 mm



wedi Fundo fire protection collar



wedi Fundo Borgo, offset drain

900 x 900 x 40 mm
1000 x 1000 x 40 mm



wedi Fundo special floor elements



Wide variety of designs, functions and sizes



Customisable without any invalidation of warranty



Precise predefined slope



With abP general appraisal certificate



Accessible and able to take the load of a wheelchair



Adjustable height for a variety of tile thicknesses



Particularly robust substructure elements



Very low weight



Drainage very simple to clean



Custom models possible



Solid **foundations**, for **well-founded** reasons.



Includes 100%
waterproof foam over
the whole system

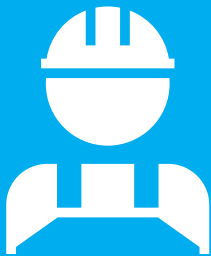
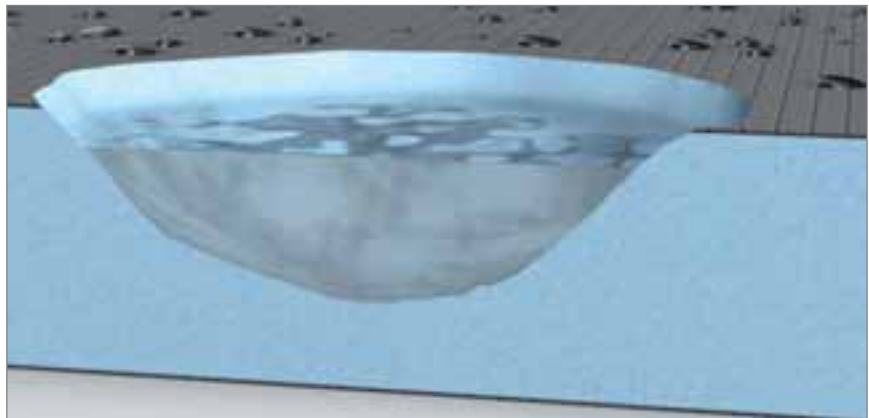

High system security
with manufacturer's
warranty



Installation benefits
save time and money



Technical properties of raw foam building board systems

Extruded polystyrene hard foam	XPS
Long-term compressive strength (50 years) \leq 2% compression EN 1606	0.08 N/mm ²
Compressive resistance or compressive strength at 10% compression EN 826	0.25 N/mm ²
Associated module of elasticity EN 826	10 – 18 N/mm ²
Thermal conductivity EN 13164	0.036 W/mK
Tensile strength EN 1607	0.45 N/mm ²
Shearing resistance EN 12090	0.2 N/mm ²
Shear modulus EN 12090	7 N/mm ²
Bulk density EN 1602	32 kg/m ³
Resistance to water vapour diffusion (μ) EN 12086	100
Water absorption under long-term immersion EN 12087	\leq 1.5 Vol.-%
Capillary action	0
Linear coefficient of thermal expansion	0,07 mm/mK
Temperature limits	-50/+75 °C
Fire behaviour DIN 4102	B1
Fire behaviour EN 13501	E
Carbon dioxide propellant GWP value	1

Technical properties of Fundo Primo / Trollo / Borgo / Nautilo

Wheelchair load-bearing from minimum tile size	50 x 50 mm
Glass mosaic from 3 mm, minimum size	20 x 20 mm
Minimum foundation height depending on the drain: horizontal drain, DN 50	130 mm
Minimum foundation height depending on the drain: horizontal drain Mini Max, DN 40	97 mm
Minimum foundation height depending on the drain: vertical drain	40 mm
Surface slope (from outer edge of Fundo floor element to outer edge of drain opening) (exception: Fundo Nautilo, 28 mm surface slope)	18 mm
Waterproof tested	1.5 bar
Fire behaviour EN 13501	E

Technical properties of Fundo Plano | horizontal drain (fixed in the element integrated) DN 40

Wheelchair load-bearing from minimum tile size	50 x 50 mm
Minimum foundation height	65 mm
Surface slope (from outer edge of Fundo Plano floor element to outer edge of drain opening)	\geq 2.4%
Frame with stainless steel grid (secured in the element)	136 x 136 x 8 mm
Stainless steel grid	132 x 132 mm
Extension frame	136 x 136 x 24.7 mm
Drainage rate	0.50 l/s ; 30.0 l/min

Technical properties of Fundo Ligno

Wheelchair load-bearing from minimum tile size	50 x 50 mm
Glass mosaic from minimum size	20 x 20 mm
Minimum foundation height depending on the drain: horizontal drain, DN 50	130 mm
Minimum foundation height depending on the drain: horizontal drain Mini Max, DN 40	97 mm
Minimum foundation height depending on the drain: vertical drain, DN 50	40 mm
Surface slope (from outer edge of Fundo floor element to outer edge of drain opening)	18 mm
Fire behaviour DIN 4102	B2

Technical properties of Fundo Plano Linea | horizontal drain (fixed in the element integrated) DN 40

Wheelchair load-bearing from minimum tile size	50 x 50 mm
Total assembly height incl. integrated drainage	70 mm
Surface slope (from outer edge of Fundo Plano Linea floor element to outer edge of drain opening)	≥ 1.19 %
Adjustment range for stainless steel covers	5 –25 mm
The Fundo Plano Linea is available with channels in the following lengths	300 to 900 mm
Drainage rate	0.40 l/s ; 24.0 l/min

Technical properties of Fundo Riolito^{neo} / Riolito / Riofino

Wheelchair load-bearing from minimum tile size	50 x 50 mm
Glass mosaic from minimum size	20 x 20 mm
Minimum foundation height depending on the drain: horizontal drain, DN 50	130 mm
Minimum foundation height depending on the drain: horizontal drain Mini Max, DN 40	97 mm
Minimum foundation height depending on the drain: vertical drain, DN 50	50 mm
Surface slope (from outer edge of floor element to outer edge drain opening)	15 mm
Waterproof tested	1.5 bar
Fire behaviour EN 13501	E





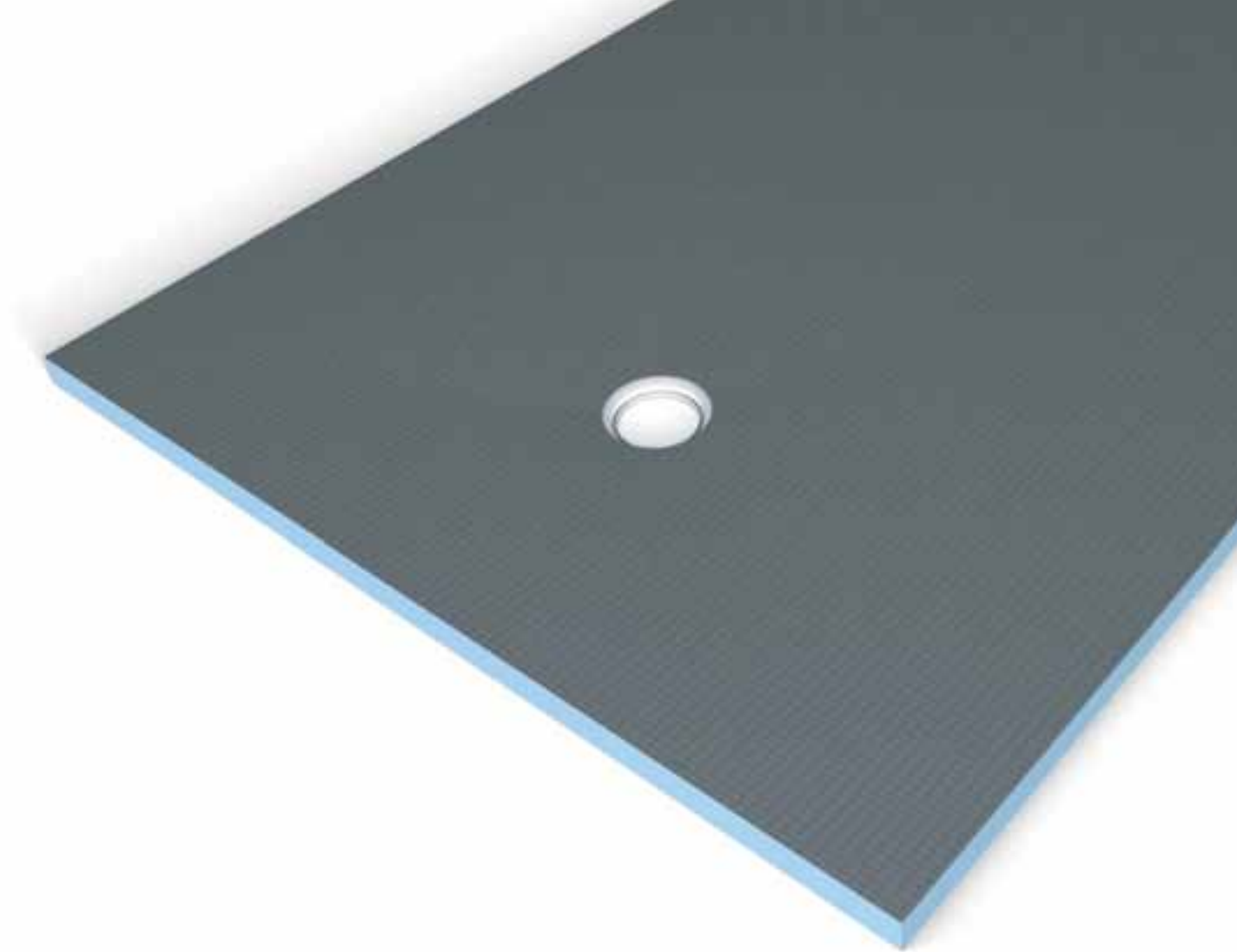

wedi Fundo *Primo*

Flush-to-floor shower element with classic point drainage

For classic point drainage in the shower, wedi Fundo Primo offers floor elements in a huge range of sizes. Whether square or rectangular, positioned in the centre of the room or in the corner, they offer the ideal solution for any space and can very easily be made into a complete shower area with the aid of the wedi building board.



Exactly uniform
predefined gradient



Huge variety of design,
function and format



Advantages for the user
save time and money

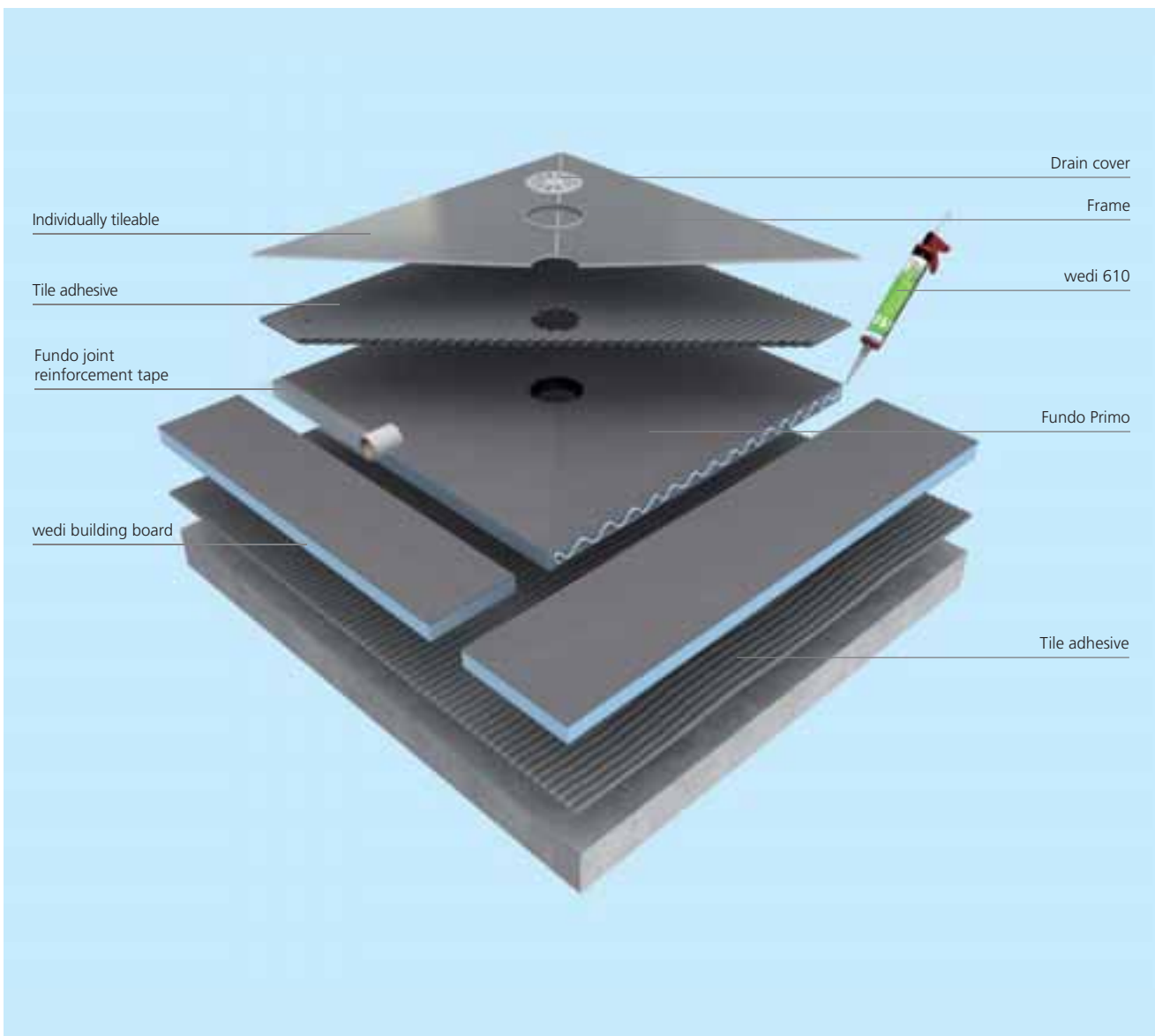

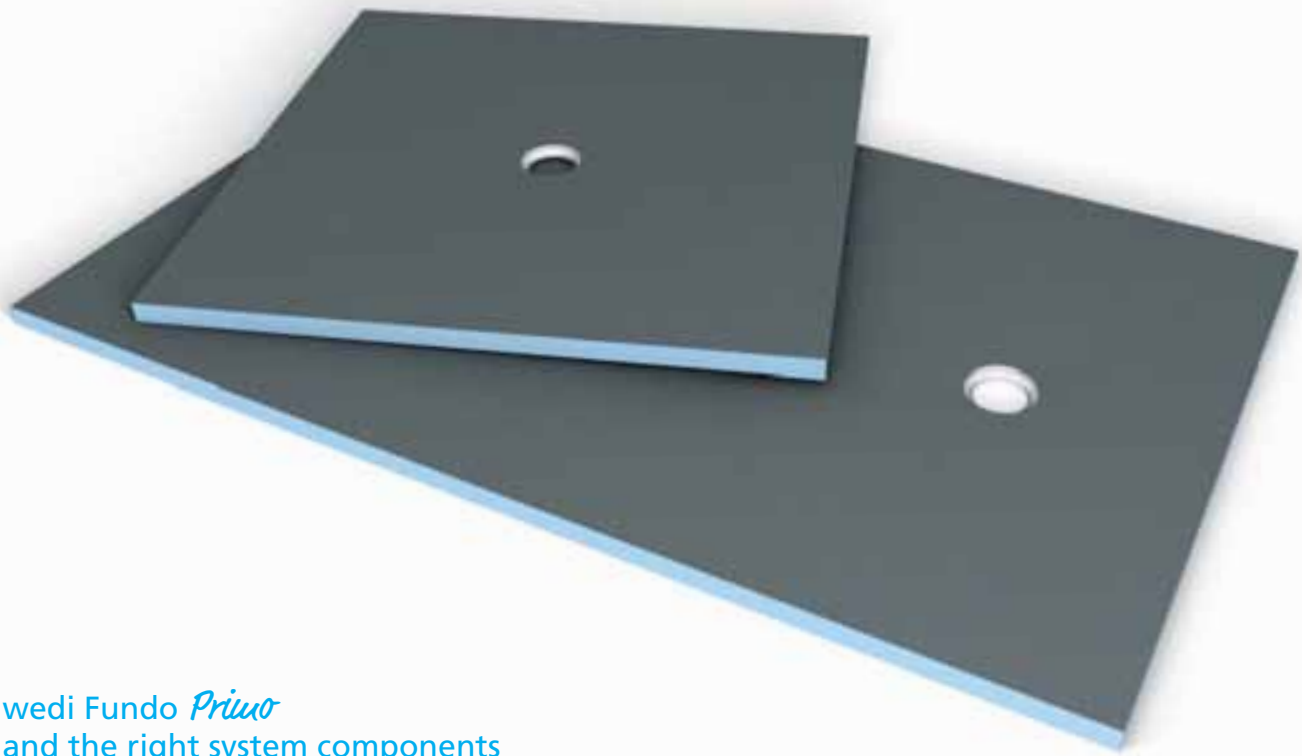

wedi Fundo *Primo* and the right system components

+ wedi Fundo drain

Thanks to the low installation height and waterproof security, the wedi drains are very well suited to new builds and renovations. There is a variety of different versions for vertical and horizontal designs.



+ wedi Fundo sealing set

The sealing set to create a waterproof connection between wedi Fundo and wedi building boards or other materials not belonging to the system, e.g. screed, plasterboard, etc.



+ wedi *Tools* joint reinforcement tape

Special (self-adhesive) glass fibre mesh tape to fix and bridge the protruding edges of structural panels.



+ wedi 610

As a versatile single-component adhesive and sealant, wedi 610 is particularly well suited to creating a waterproof joint between wedi components. The combination of wedi building board and wedi 610 has an abP general appraisal certificate for the heavy-duty area.



Drain versions Point drainage

Fundo horizontal drain, DN 50, screed flooring

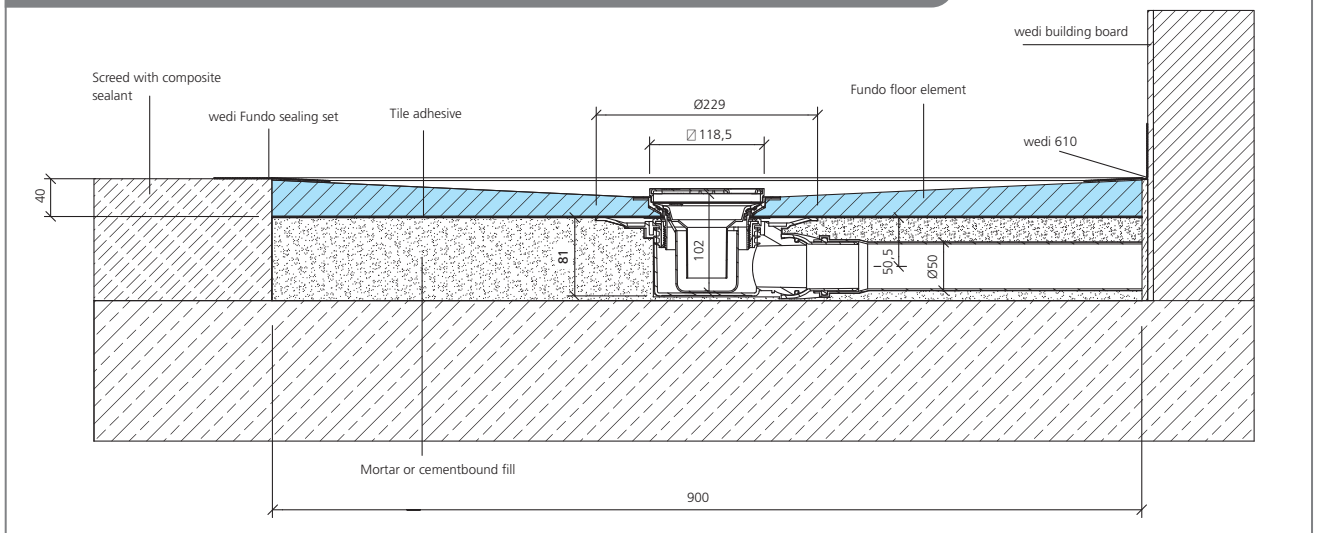

Fundo vertical drain, DN 50, screed flooring (also available with fire breakpoint and DN 70)

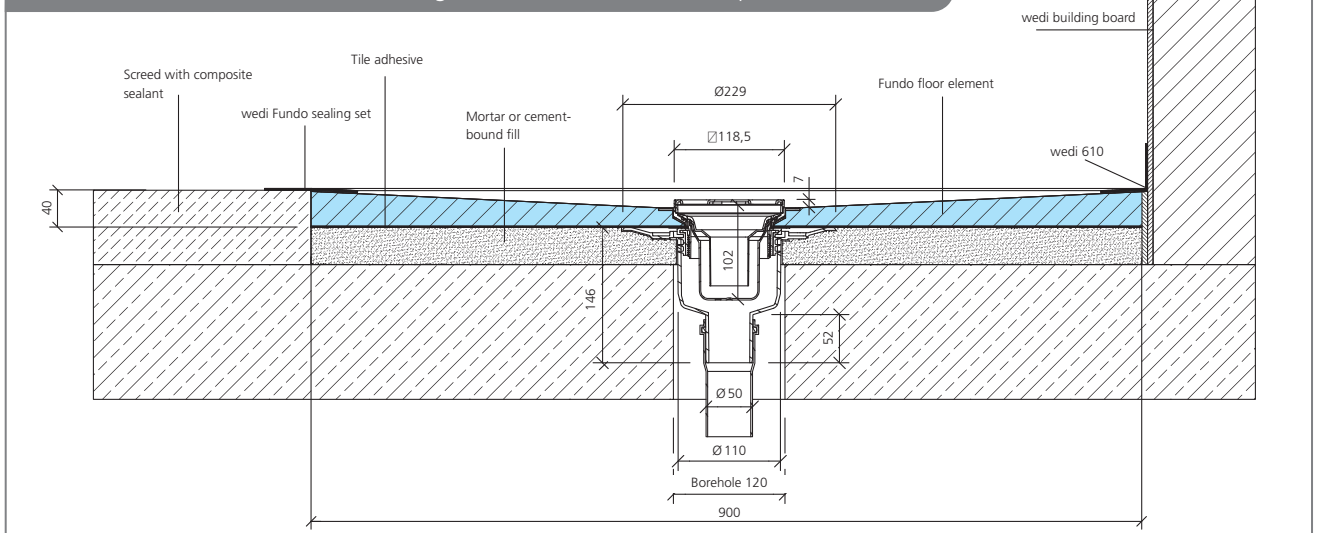

Fundo drain Mini Max drain, DN 40

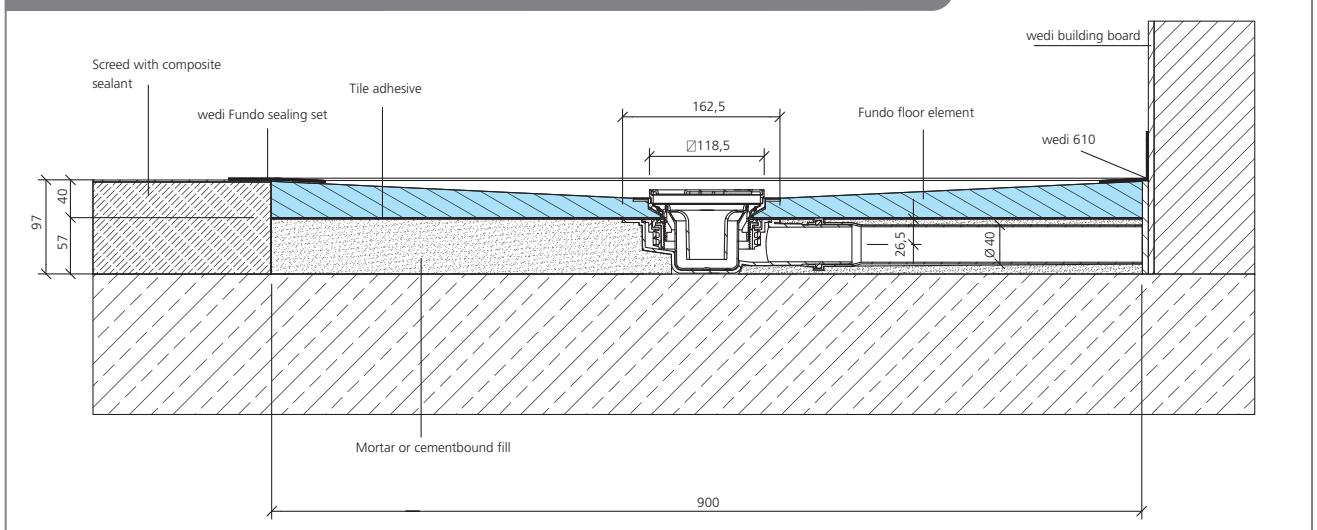

i You will find further technical drawings in the relevant assembly instructions and in the "Creation of flush-to-floor showers" brochure.

Item numbers and designs

1st selection: Floor element

	Length x width x thickness	Packaging unit	Order no.
wedi Fundo Primo, square floor element, central drain	900 x 900 x 40 mm	10 units	07-37-35/170
wedi Fundo Primo, square floor element, central drain	1000 x 1000 x 40 mm	10 units	07-37-35/131
wedi Fundo Primo, square floor element, central drain	1200 x 1200 x 40 mm	10 units	07-37-35/171
wedi Fundo Primo, square floor element, central drain	1500 x 1500 x 40 mm	10 units	07-37-35/175
wedi Fundo Primo, square floor element, corner drain	900 x 900 x 40 mm	10 units	07-37-36/170
wedi Fundo Primo, square floor element, corner drain	1000 x 1000 x 40 mm	10 units	07-37-35/531
wedi Fundo Primo, square floor element, corner drain	1200 x 1200 x 40 mm	10 units	07-37-36/171
wedi Fundo Primo, square floor element, corner drain	1500 x 1500 x 40 mm	10 units	07-37-36/175
wedi Fundo Primo, rectangular floor element, central drain	900 x 750 x 40 mm	10 units	07-37-35/176
wedi Fundo Primo, rectangular floor element, central drain	1200 x 900 x 40 mm	10 units	07-37-35/174
wedi Fundo Primo, rectangular floor element, central drain	1400 x 900 x 40 mm	10 units	07-37-35/196
wedi Fundo Primo, rectangular floor element, central drain	1500 x 900 x 40 mm	10 units	07-37-36/120
wedi Fundo Primo, rectangular floor element, central drain	1800 x 900 x 40 mm	10 units	07-37-35/580
wedi Fundo Primo, rectangular floor element, central drain	1400 x 1000 x 40 mm	10 units	07-37-35/198
wedi Fundo Primo, rectangular floor element, central drain	1500 x 1000 x 40 mm	10 units	07-37-36/121
wedi Fundo Primo, rectangular floor element, offset drain	1200 x 900 x 40 mm	10 units	07-37-36/174
wedi Fundo Primo, rectangular floor element, offset drain	1800 x 900 x 40 mm	10 units	07-37-35/180

2nd selection: Drain

	Packaging unit	Order no.
wedi Fundo vertical drain, DN 50, square, drainage capacity 1.00 l/s ; 60.0 l/min	1 unit	07-70-00/007
wedi Fundo vertical drain, DN 50, round, drainage capacity 1.00 l/s ; 60.0 l/min	1 unit	07-70-00/008
wedi Fundo vertical drain, DN 50, with fire protection collar, drainage capacity 1.00 l/s ; 60.0 l/min	1 unit	07-37-49/002
wedi Fundo vertical drain, DN 70, drainage capacity 0.88 l/s ; 52.8 l/min	1 unit	07-70-00/010
wedi Fundo horizontal drain, DN 50, square, drainage capacity 0.80 l/s ; 48.0 l/min	1 unit	07-70-00/011
wedi Fundo horizontal drain, DN 50, round, drainage capacity 0.80 l/s ; 48.0 l/min	1 unit	07-70-00/012
wedi Fundo drain Mini Max, DN 40, extra-flat, drainage capacity 0.54 l/s ; 32.4 l/min	1 unit	07-70-00/015

3rd selection: Sealant

	Quantity / length x width	Packaging unit	Order no.
Version 1 – Installation in screed; no wall/floor connection with wedi building board			
wedi Fundo sealing set		1 pail	07-37-96/000
wedi Tools, sealing tape, fleece-lined	50 m x 100 mm	1 roll	09-51-00/352
wedi Tools, sealing tape, fleece-lined	10 m x 120 mm	1 roll	09-51-10/311
wedi Tools, sealing tape, fleece-lined	50 m x 120 mm	1 roll	09-51-10/352
wedi Tools, inside corners, fleece laminated	120 x 120 mm	25 units	09-51-30/001
wedi Tools, outside corners, fleece laminated	115 x 115 mm	25 units	09-51-35/001
Version 2 – Installation on the floor; connection to wall/floor with wedi building board			
wedi 610, adhesive sealant	310 ml / 1 cartridge	20 units	07-69-02/002
wedi Tools, joint reinforcement tape	25 m x 125 mm	1 roll	09-52-20/053
wedi Tools, joint reinforcement tape, self-adhesive	25 m x 125 mm	1 roll	09-52-25/053



You can find countless expansion options for your shower or complete bathroom conversion in the wedi product range.



All installation instructions can be found using this QR code.





wedi Fundo *Riolito*^{neo}

Flush-to-floor shower element
with close-to-wall linear drainage

Thanks to a new, more slimline drain in an oval design, the height-adjustable drain channel of the new Fundo Riolito^{neo} is now very close to the wall. The completely integrated slope profile enables an almost jointless installation of large format tiles of differing thickness (5 – 25 mm).



Linear drainage extremely close to the wall



Drain channel with integrated height adjustment



Several format configurations with long and short channels

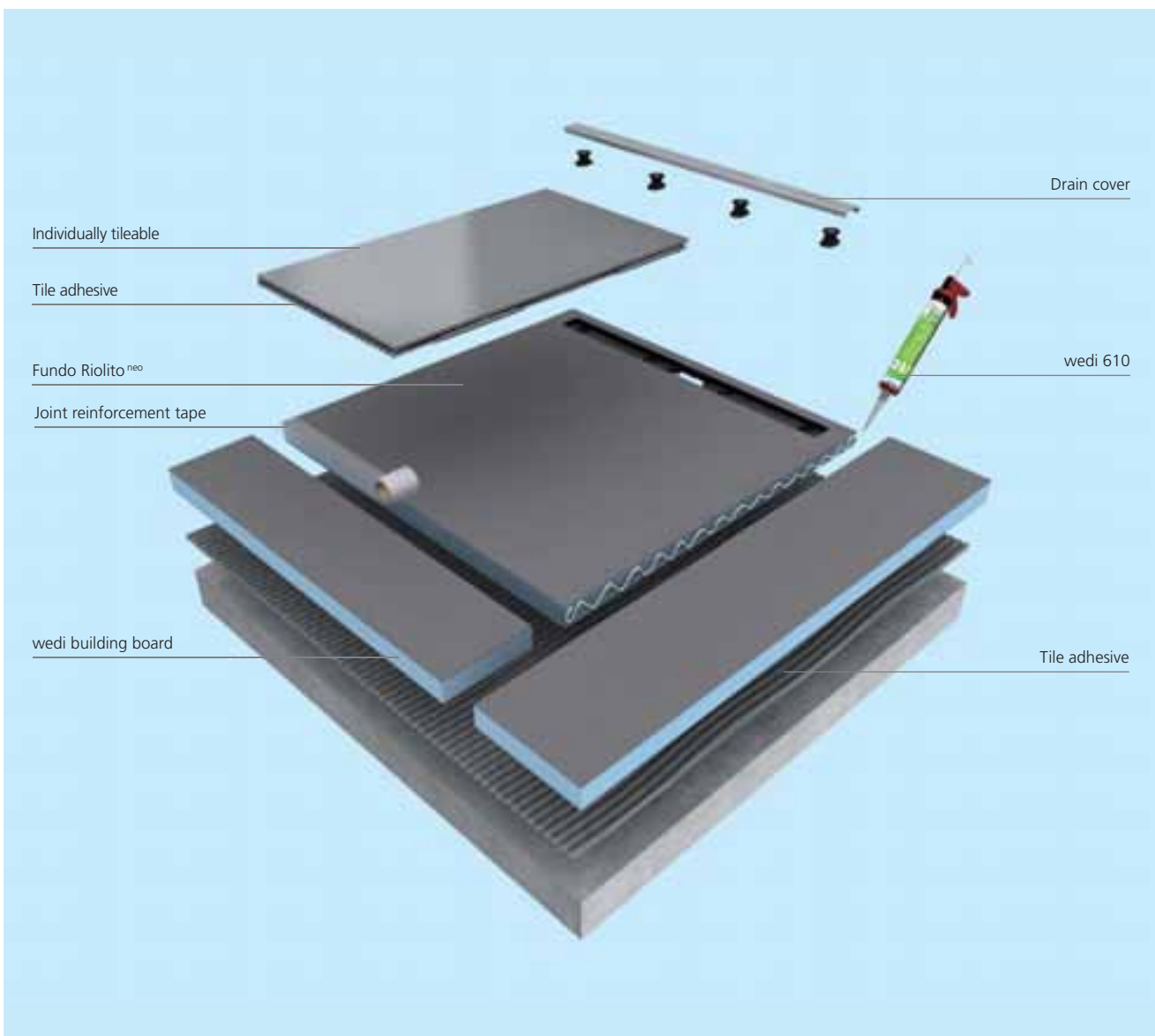

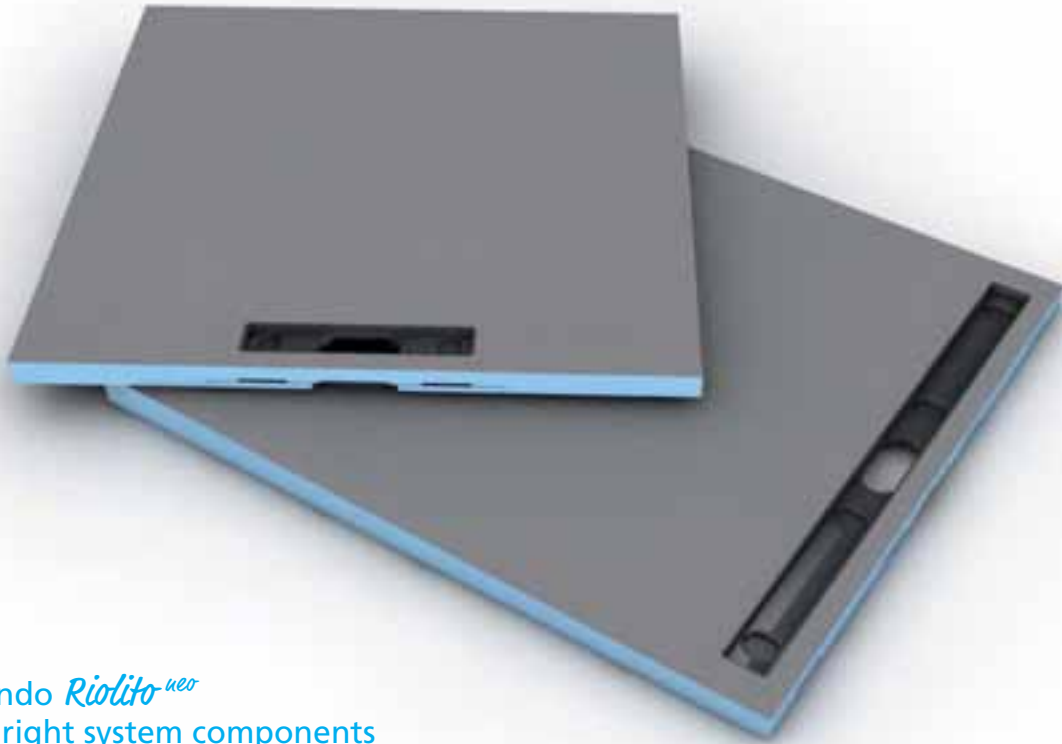

wedi Fundo *Riolito*^{neo} and the right system components

+ wedi 610

As a versatile single-component adhesive and sealant, wedi 610 is particularly well suited to creating a waterproof joint between wedi components. The combination of wedi building board and wedi 610 has an abP general appraisal certificate for the heavy-duty area.



+ wedi Fundo *Riolito*^{neo} drain

Thanks to the low installation height and waterproof security, the wedi drains are very well suited to new builds and renovations. There is a variety of different versions for vertical and horizontal designs.



+ wedi Fundo sealing set

The sealing set to create a waterproof connection between wedi Fundo and wedi building boards or other materials not belonging to the system, e.g. screed, plasterboard, etc.



+ wedi Fundo *Riolito*^{neo} linear channel covers

The high quality brushed stainless steel covers compliment the superbly designed wedi Fundo Riolito^{neo} floor elements.

Design versions: standard, exclusive and tileable



Drain versions Linear drainage

Fundo Riolito^{neo} horizontal drain, DN 50, screed flooring

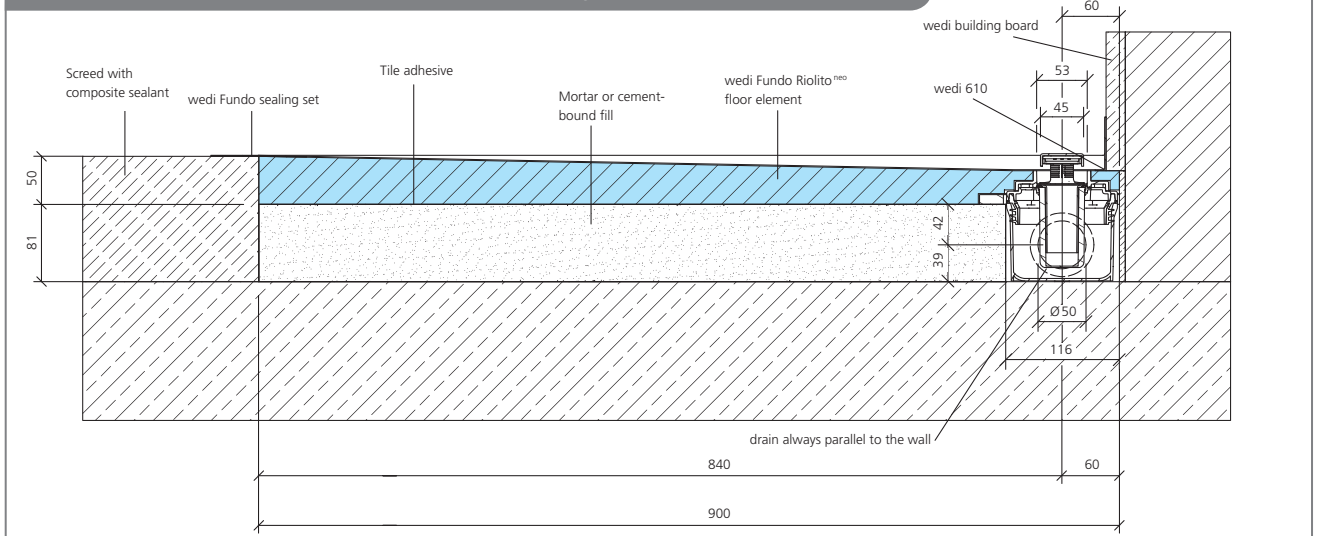

Fundo Riolito^{neo} vertical drain, DN 50, screed flooring

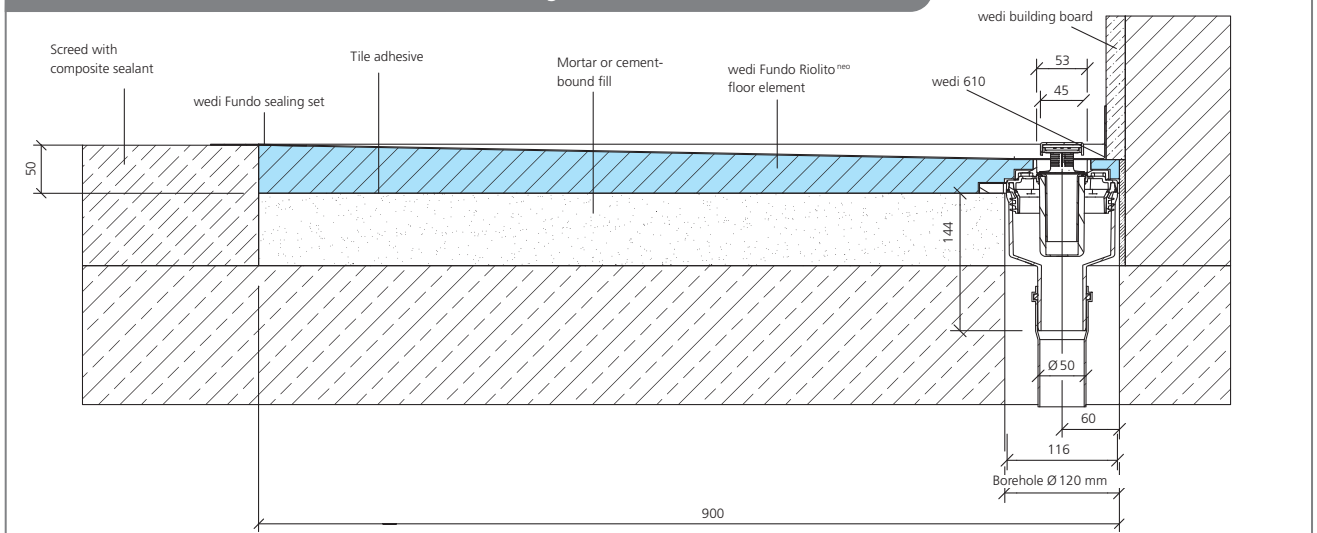

Fundo drain Riolito^{neo} Mini Max, DN 40

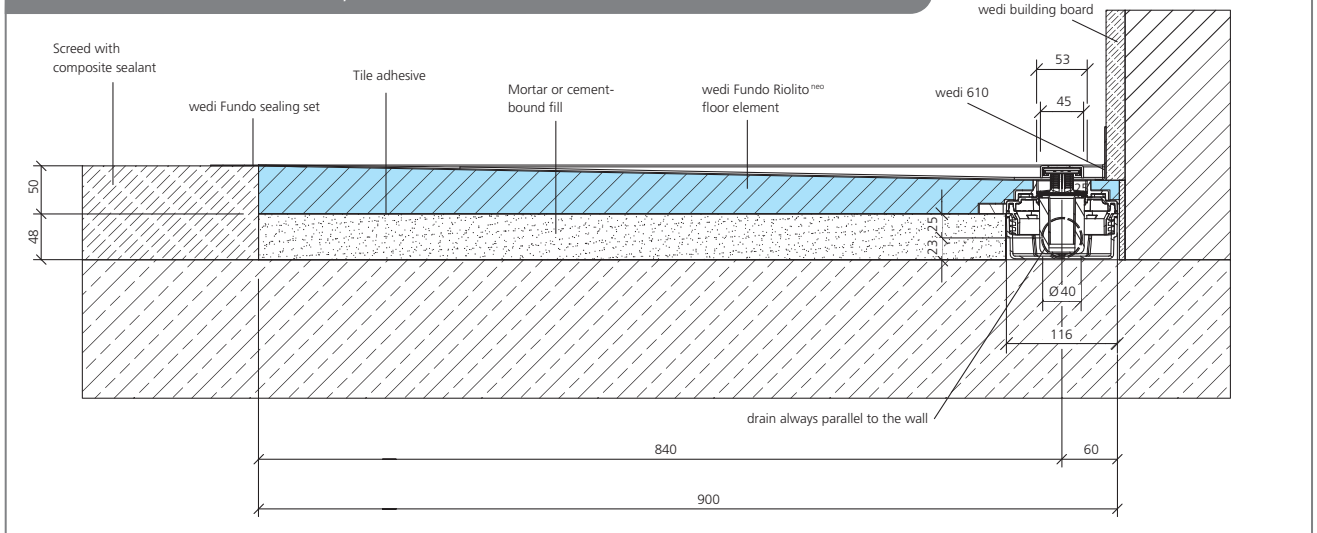

i You will find further technical drawings in the relevant assembly instructions and in the "Creation of flush-to-floor showers" brochure.

Item numbers and designs

1st selection: Floor element

	Length x width x thickness	Gutter length	Order no.
wedi Fundo Riolito ^{neo} , floor element with channel, rectangular	1200 x 800 x 50 mm	700 mm	07-51-00/001
wedi Fundo Riolito ^{neo} , floor element with channel, rectangular	1200 x 900 x 50 mm	800 mm	07-51-00/004
wedi Fundo Riolito ^{neo} , floor element with channel, rectangular	1400 x 900 x 50 mm	700 mm	07-51-00/033
wedi Fundo Riolito ^{neo} , floor element with channel, rectangular	1800 x 900 x 60 mm	800 mm	07-51-00/005
wedi Fundo Riolito ^{neo} , floor element with channel, rectangular	1200 x 1000 x 50 mm	900 mm	07-51-00/008
wedi Fundo Riolito ^{neo} , floor element with channel, rectangular	1600 x 1000 x 50 mm	800 mm	07-51-00/034
wedi Fundo Riolito ^{neo} , floor element with channel, square	900 x 900 x 50 mm	800 mm	07-51-00/003
wedi Fundo Riolito ^{neo} , floor element with channel, square	1000 x 1000 x 50 mm	800 mm	07-51-00/032
wedi Fundo Riolito ^{neo} , floor element with channel, square	1200 x 1200 x 50 mm	1100 mm	07-51-00/010
wedi Fundo Riolito ^{neo} , floor element with short channel, square	900 x 900 x 50 mm	300 mm	07-51-00/031

2nd selection: Drain

	Packaging unit	Order no.
wedi Fundo Riolito ^{neo} , vertical drain, DN 50, drainage capacity 1.12 l/s ; 67.2 l/min	1 unit	07-70-00/014
wedi Fundo Riolito ^{neo} , horizontal drain, DN 50, drainage capacity 0.80 l/s ; 48.0 l/min	1 unit	07-70-00/016
wedi Fundo Riolito ^{neo} Mini Max, drain, DN 40, extra-flat, drainage capacity 0.40 l/s; 24 l/min	1 unit	07-70-00/017

3rd selection: Sealant

	Quantity / length x width	Packaging unit	Order no.
Version 1 – Installation in screed; no wall/floor connection with wedi building board			
wedi Fundo sealing set		1 pail	07-37-96/000
wedi Tools, sealing tape, fleece-lined	50 m x 100 mm	1 roll	09-51-00/352
wedi Tools, sealing tape, fleece-lined	10 m x 120 mm	1 roll	09-51-10/311
wedi Tools, sealing tape, fleece-lined	50 m x 120 mm	1 roll	09-51-10/352
wedi Tools, inside corners, fleece laminated	120 x 120 mm	25 units	09-51-30/001
wedi Tools, outside corners, fleece laminated	115 x 115 mm	25 units	09-51-35/001
Version 2 – Installation on the floor; connection to wall/floor with wedi building board			
wedi 610, adhesive sealant	310 ml / 1 cartridge	20 units	07-69-02/002
wedi Tools, joint reinforcement tape	25 m x 125 mm	1 roll	09-52-20/053
wedi Tools, joint reinforcement tape, self-adhesive	25 m x 125 mm	1 roll	09-52-25/053

4th selection: linear channel covers

	Length x width x thickness	Packaging unit	Order no.
wedi Fundo linear channel cover standard, stainless steel in 1.5 mm thickness, brushed	300 x 40 x 18 mm	1 unit	67-68-00/010
wedi Fundo linear channel cover standard, stainless steel in 1.5 mm thickness, brushed	700 x 40 x 18 mm	1 unit	67-68-00/009
wedi Fundo linear channel cover standard, stainless steel in 1.5 mm thickness, brushed	800 x 40 x 18 mm	1 unit	67-68-00/008
wedi Fundo linear channel cover standard, stainless steel in 1.5 mm thickness, brushed	900 x 40 x 18 mm	1 unit	67-68-00/007
wedi Fundo linear channel cover standard, stainless steel in 1.5 mm thickness, brushed	1100 x 40 x 18 mm	1 unit	67-68-00/006
wedi Fundo linear channel cover exclusive, solid stainless steel in 1.5 mm thickness, brushed	300 x 40 x 21 mm	1 unit	67-68-00/001
wedi Fundo linear channel cover exclusive, solid stainless steel in 1.5 mm thickness, brushed	700 x 40 x 21 mm	1 unit	67-68-00/002
wedi Fundo linear channel cover exclusive, solid stainless steel in 1.5 mm thickness, brushed	800 x 40 x 21 mm	1 unit	67-68-00/003
wedi Fundo linear channel cover exclusive, solid stainless steel in 1.5 mm thickness, brushed	900 x 40 x 21 mm	1 unit	67-68-00/004
wedi Fundo linear channel cover exclusive, solid stainless steel in 1.5 mm thickness, brushed	1100 x 40 x 21 mm	1 unit	67-68-00/005
wedi Fundo linear channel cover tileable, stainless steel	300 x 40 x 18 mm	1 unit	67-68-00/011
wedi Fundo linear channel cover tileable, stainless steel	700 x 40 x 18 mm	1 unit	67-68-00/012
wedi Fundo linear channel cover tileable, stainless steel	800 x 40 x 18 mm	1 unit	67-68-00/013
wedi Fundo linear channel cover tileable, stainless steel	900 x 40 x 18 mm	1 unit	67-68-00/014
wedi Fundo linear channel cover tileable, stainless steel	1100 x 40 x 18 mm	1 unit	67-68-00/015



You can find countless expansion options for your shower or complete bathroom conversion in the wedi product range.



All installation instructions can be found using this QR code.





wedi Fundo *Riolito*

Flush-to-floor shower element with sophisticated linear drainage

This flush-to-floor shower element is captivating with its sophisticated linear drainage. With all Riolito designs, this is positioned to the side. The exact gradient required for this is already incorporated into the floor elements.



Leading solution for accessible bathrooms



No risk when fitting due to high degree of system reliability



Simpler and quicker installation

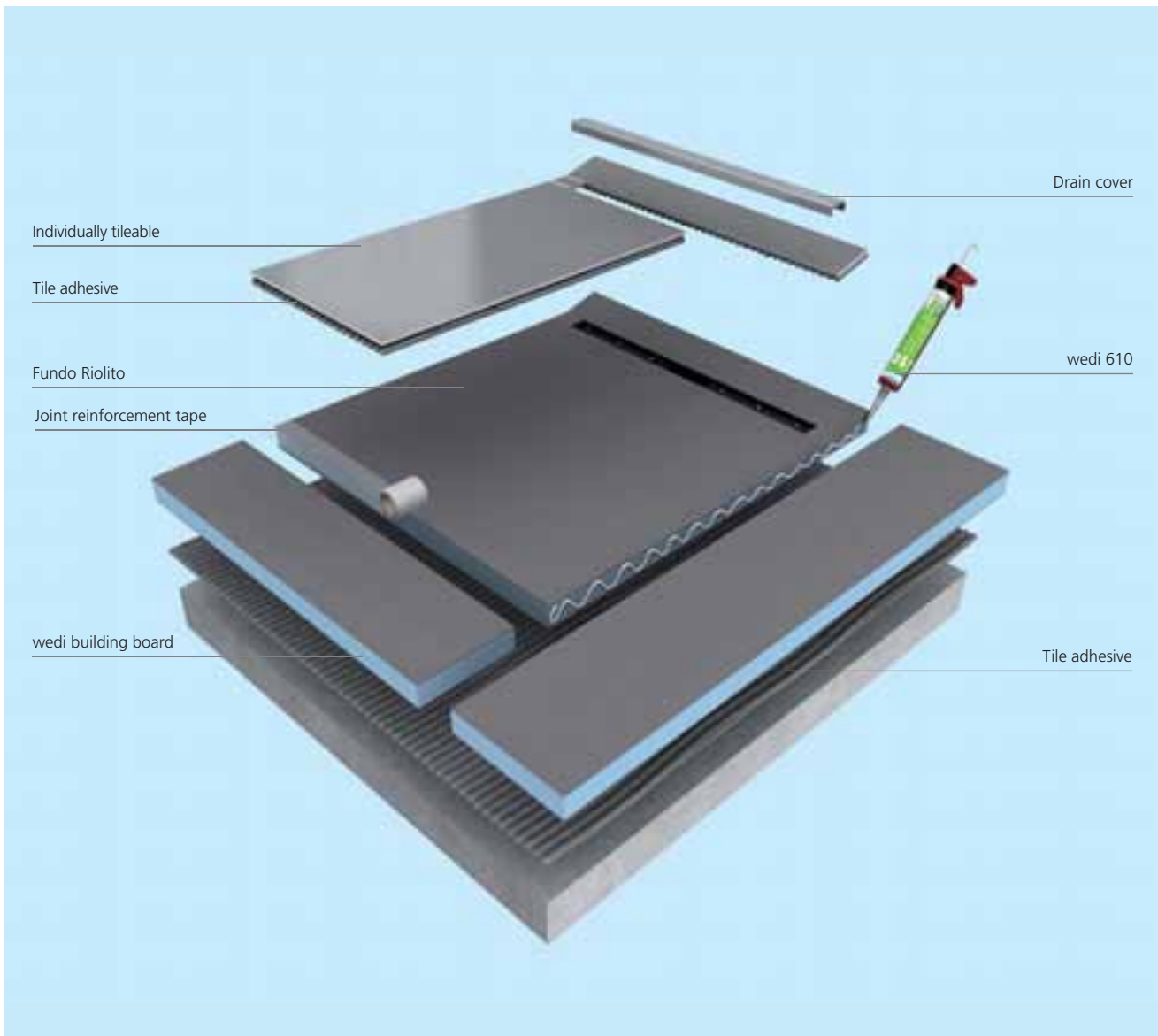



wedi Fundo *Riolito* and the right system components

+ wedi 610

As a versatile single-component adhesive and sealant, wedi 610 is particularly well suited to creating a waterproof joint between wedi components. The combination of wedi building board and wedi 610 has an abP general appraisal certificate for the heavy-duty area.



+ wedi Fundo *Riolito* / *Riofino* drain

Thanks to the low installation height and waterproof security, the wedi drains are very well suited to new builds and renovations. There is a variety of different versions for vertical and horizontal designs.



+ wedi Fundo sealing set

The sealing set to create a waterproof connection between wedi Fundo and wedi building boards or other materials not belonging to the system, e.g. screed, plasterboard, etc.



+ wedi Fundo *Riolito* drain covers

The high quality brushed stainless steel covers complete the design demand of the wedi Fundo Riolito floor elements.

Design versions: standard, exclusive and tileable



Drain versions Linear drainage

Fundo Riolito horizontal drain, DN 50, screed flooring

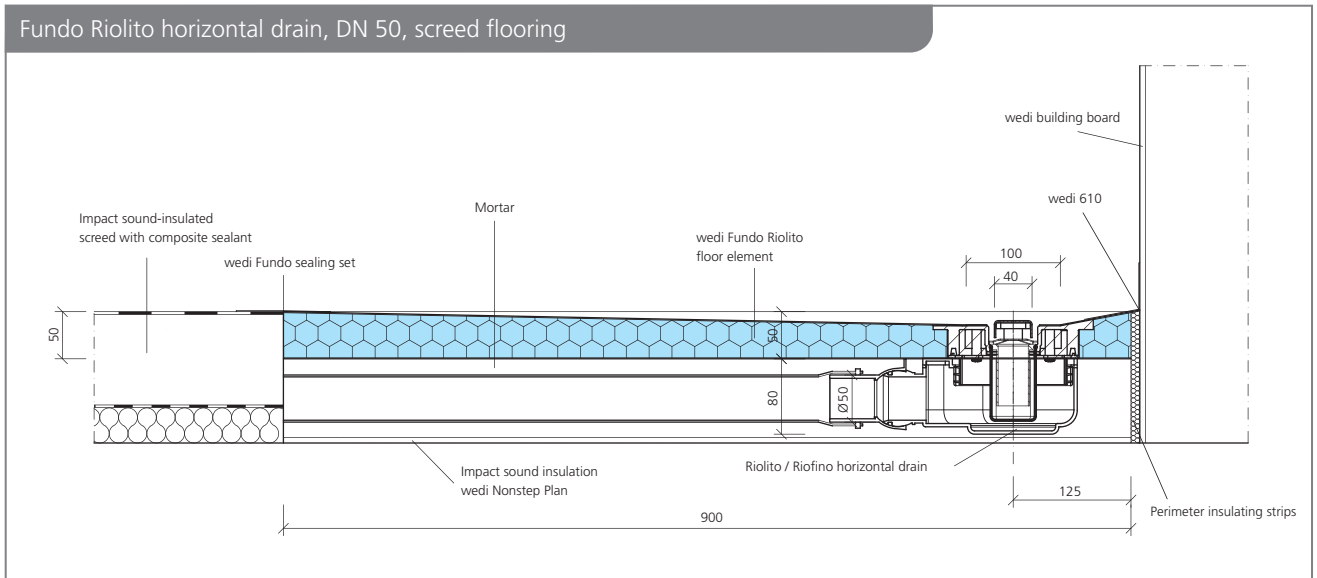

Fundo Riolito vertical drain, DN 50, screed flooring (also available with fire breakpoint)

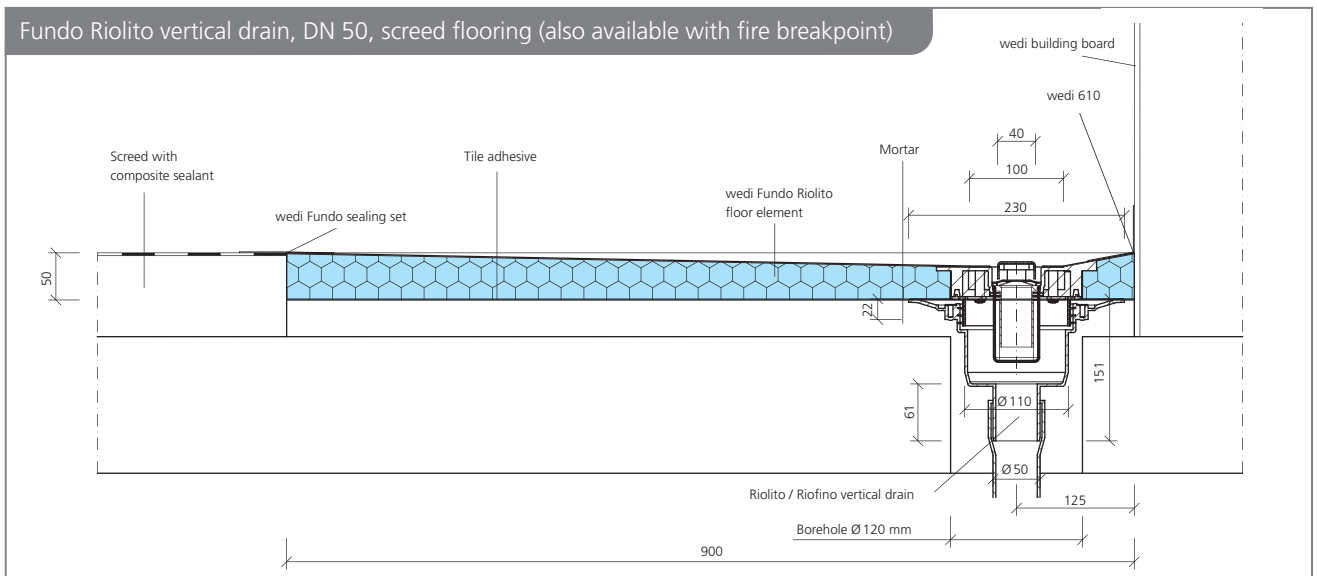

Fundo drain Riolito Mini Max, DN 40

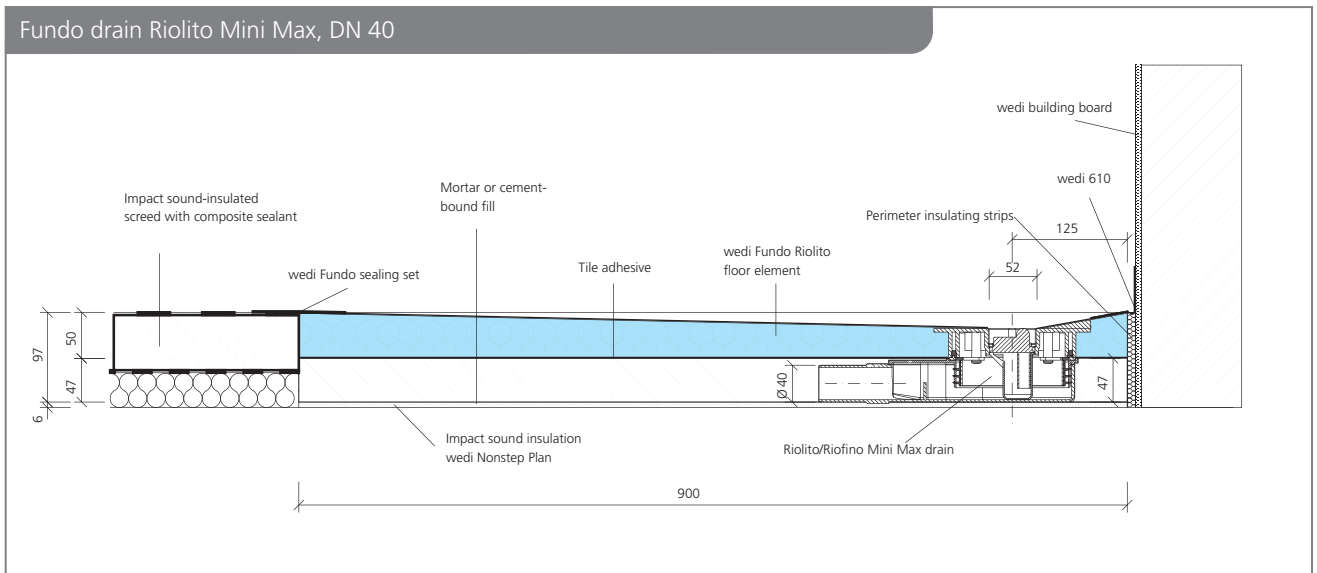

i You will find further technical drawings in the relevant assembly instructions and in the "Creation of flush-to-floor showers" brochure.

Item numbers and designs

1st selection: Floor element

	Length x width x thickness	Gutter length	Order no.
wedi Fundo Riolito, floor element with channel, rectangular	1200 x 800 x 50 mm	700 mm	07-37-34/351
wedi Fundo Riolito, floor element with channel, rectangular	1200 x 900 x 50 mm	800 mm	07-37-34/356
wedi Fundo Riolito, floor element with channel, rectangular	1400 x 900 x 50 mm	700 mm	07-37-34/361
wedi Fundo Riolito, floor element with channel, rectangular	1800 x 900 x 60 mm	800 mm	07-37-34/358
wedi Fundo Riolito, floor element with channel, rectangular	1200 x 1000 x 50 mm	900 mm	07-37-34/352
wedi Fundo Riolito, floor element with channel, rectangular	1600 x 1000 x 50 mm	800 mm	07-37-34/362
wedi Fundo Riolito, floor element with channel, square	900 x 900 x 50 mm	800 mm	07-37-34/354
wedi Fundo Riolito, floor element with channel, square	1000 x 1000 x 50 mm	800 mm	07-37-34/360
wedi Fundo Riolito, floor element with channel, square	1200 x 1200 x 50 mm	1100 mm	07-37-34/355
wedi Fundo Riolito, floor element with short channel, square	900 x 900 x 50 mm	300 mm	07-37-34/359

2nd selection: drain

	Packaging unit	Order no.
wedi Fundo Riolito / Riofino, vertical drain, DN 50, drainage capacity 1.12 l/s ; 67.2 l/min	1 unit	07-37-89/013
wedi Fundo Riolito / Riofino, vertical drain, DN 50 with fire breakpoint, drainage capacity 1.12 l/s ; 67.2 l/min	1 unit	07-37-89/012
wedi Fundo Riolito / Riofino, horizontal drain, DN 50, drainage capacity 0.80 l/s ; 48.0 l/min	1 unit	07-37-90/004
wedi Fundo Riolito / Riofino Mini Max, drain, DN 40, extra-flat, drainage capacity 0.40 l/s; 24 l/min	1 unit	07-37-90/006

3rd selection: Sealant

	Quantity / length x width	Packaging unit	Order no.
Version 1 – Installation in screed; no wall/floor connection with wedi building board			
wedi Fundo sealing set		1 pail	07-37-96/000
wedi Tools, sealing tape, fleece-lined	50 m x 100 mm	1 roll	09-51-00/352
wedi Tools, sealing tape, fleece-lined	10 m x 120 mm	1 roll	09-51-10/311
wedi Tools, sealing tape, fleece-lined	50 m x 120 mm	1 roll	09-51-10/352
wedi Tools, inside corners, fleece laminated	120 x 120 mm	25 units	09-51-30/001
wedi Tools, outside corners, fleece laminated	115 x 115 mm	25 units	09-51-35/001
Version 2 – Installation on the floor; connection to wall/floor with wedi building board			
wedi 610, adhesive sealant	310 ml / 1 cartridge	20 units	07-69-02/002
wedi Tools, joint reinforcement tape	25 m x 125 mm	1 roll	09-52-20/053
wedi Tools, joint reinforcement tape, self-adhesive	25 m x 125 mm	1 roll	09-52-25/053

4th selection: linear channel covers

	Length x width x thickness	Packaging unit	Order no.
wedi Fundo Riolito/Riofino linear channel cover standard, stainless steel in 1.5 mm thickness, brushed	300 x 40 x 18 mm	1 unit	67-67-97/013
wedi Fundo Riolito linear channel cover standard, stainless steel in 1.5 mm thickness, brushed	700 x 40 x 18 mm	1 unit	67-67-97/012
wedi Fundo Riolito linear channel cover standard, stainless steel in 1.5 mm thickness, brushed	800 x 40 x 18 mm	1 unit	67-67-97/011
wedi Fundo Riolito linear channel cover standard, stainless steel in 1.5 mm thickness, brushed	900 x 40 x 18 mm	1 unit	67-67-97/010
wedi Fundo Riolito linear channel cover standard, stainless steel in 1.5 mm thickness, brushed	1100 x 40 x 18 mm	1 unit	67-67-97/009
wedi Fundo Riolito/Riofino linear channel cover exclusive, solid stainless steel in 1.5 mm thickness, brushed	300 x 40 x 21 mm	1 unit	67-67-97/004
wedi Fundo Riolito linear channel cover exclusive, solid stainless steel in 1.5 mm thickness, brushed	700 x 40 x 21 mm	1 unit	67-67-97/005
wedi Fundo Riolito linear channel cover exclusive, solid stainless steel in 1.5 mm thickness, brushed	800 x 40 x 21 mm	1 unit	67-67-97/006
wedi Fundo Riolito linear channel cover exclusive, solid stainless steel in 1.5 mm thickness, brushed	900 x 40 x 21 mm	1 unit	67-67-97/007
wedi Fundo Riolito linear channel cover exclusive, solid stainless steel in 1.5 mm thickness, brushed	1100 x 40 x 21 mm	1 unit	67-67-97/008
wedi Fundo Riolito/Riofino linear channel cover tileable, stainless steel	300 x 40 x 18 mm	1 unit	67-67-97/014
wedi Fundo Riolito linear channel cover tileable, stainless steel	700 x 40 x 18 mm	1 unit	67-67-97/015
wedi Fundo Riolito linear channel cover tileable, stainless steel	800 x 40 x 18 mm	1 unit	67-67-97/016
wedi Fundo Riolito linear channel cover tileable, stainless steel	900 x 40 x 18 mm	1 unit	67-67-97/017
wedi Fundo Riolito linear channel cover tileable, stainless steel	1100 x 40 x 18 mm	1 unit	67-67-97/018



You can find countless expansion options for your shower or complete bathroom conversion in the wedi product range.



All installation instructions can be found using this QR code.



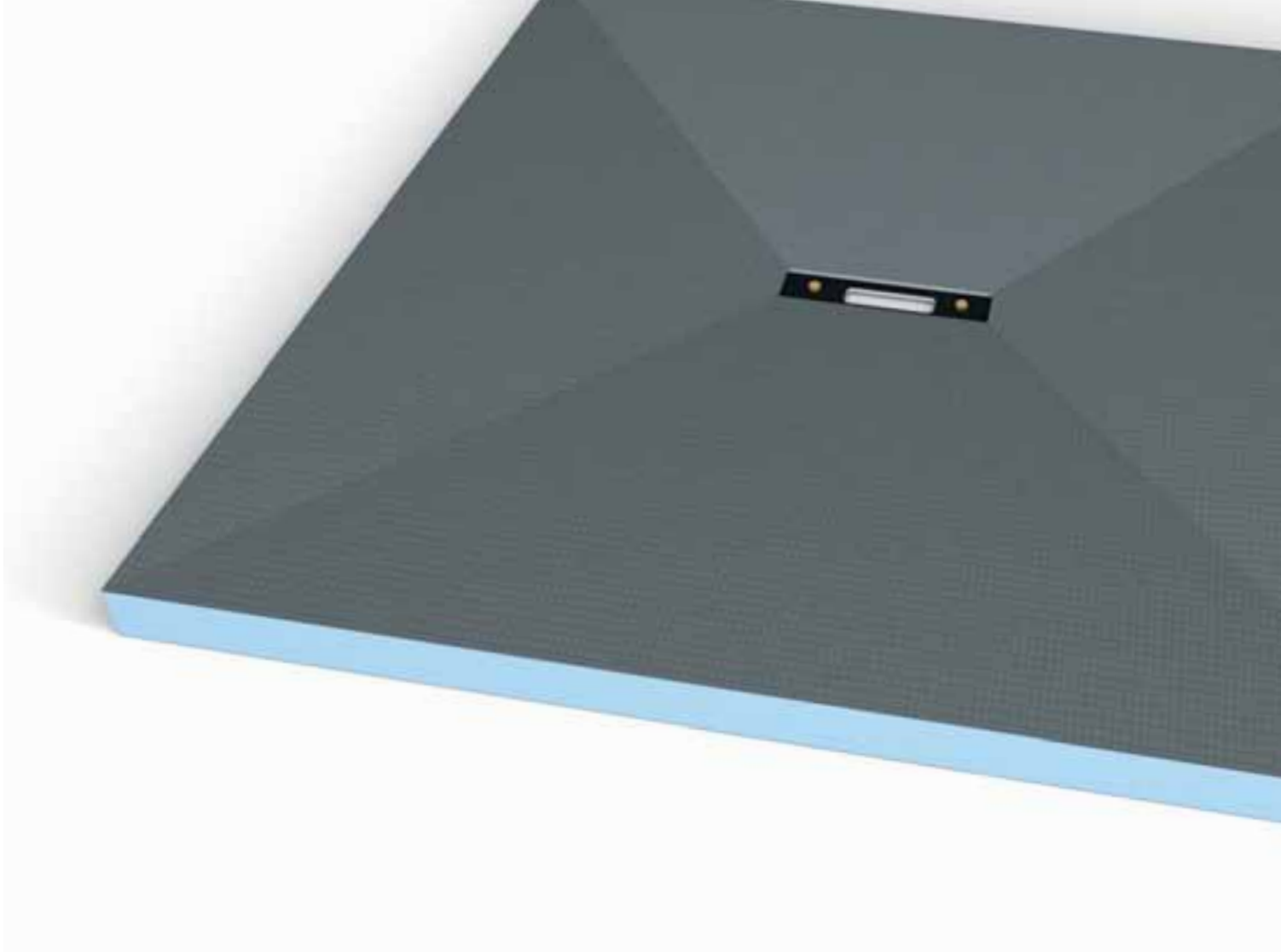

wedi Fundo *Riofino*

Flush-to-floor shower element with
central linear drainage

A different kind of linear drainage – streamlined and centred. This is the wedi Fundo Riofino floor element. Sophisticated in its finish, extraordinary in design, quick and safe in its drainage and it completely impresses.



Can be individually adapted without
forfeiting your guarantee



Checked and licensed with abP
general appraisal certificate



Very low
weight

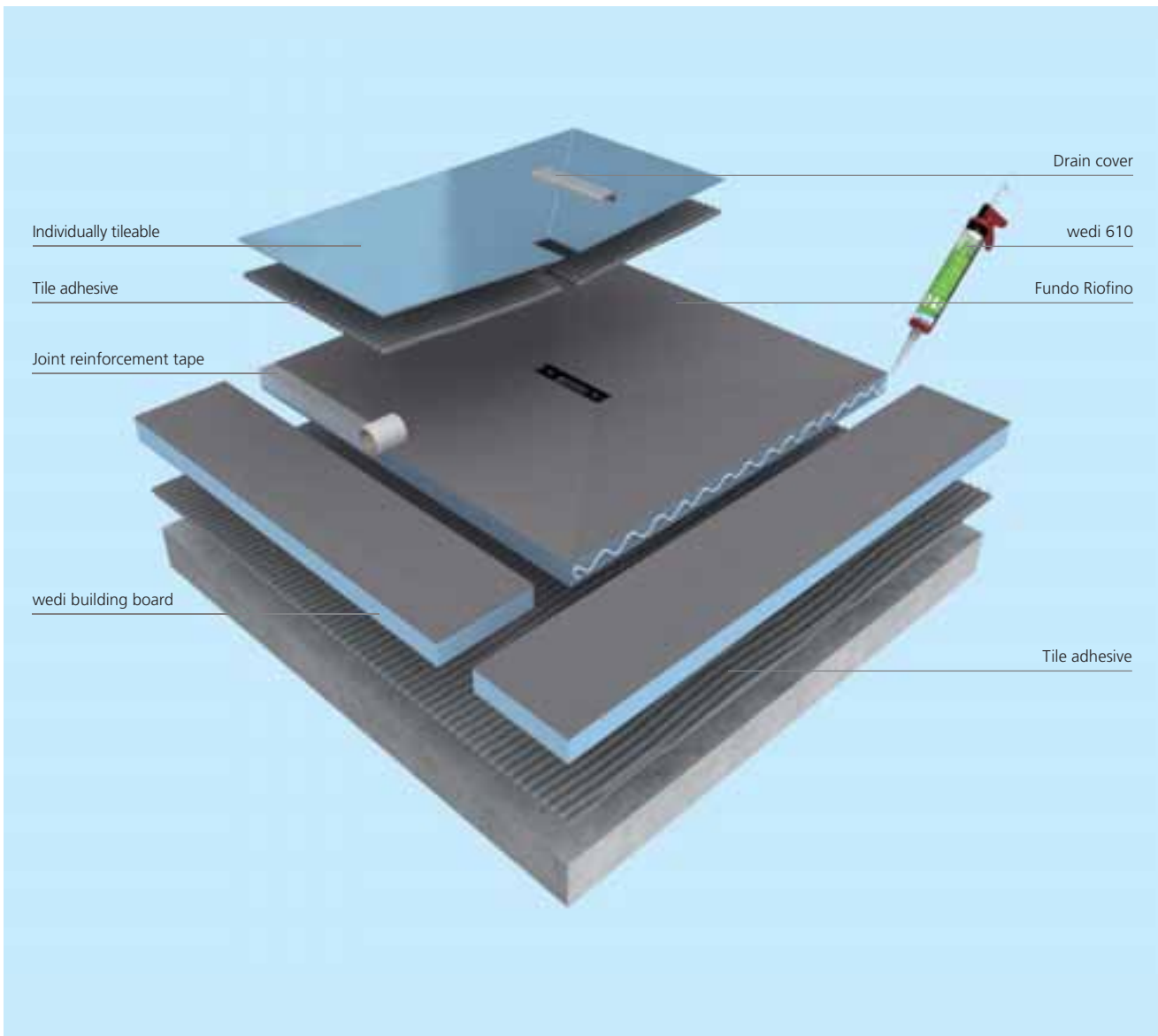
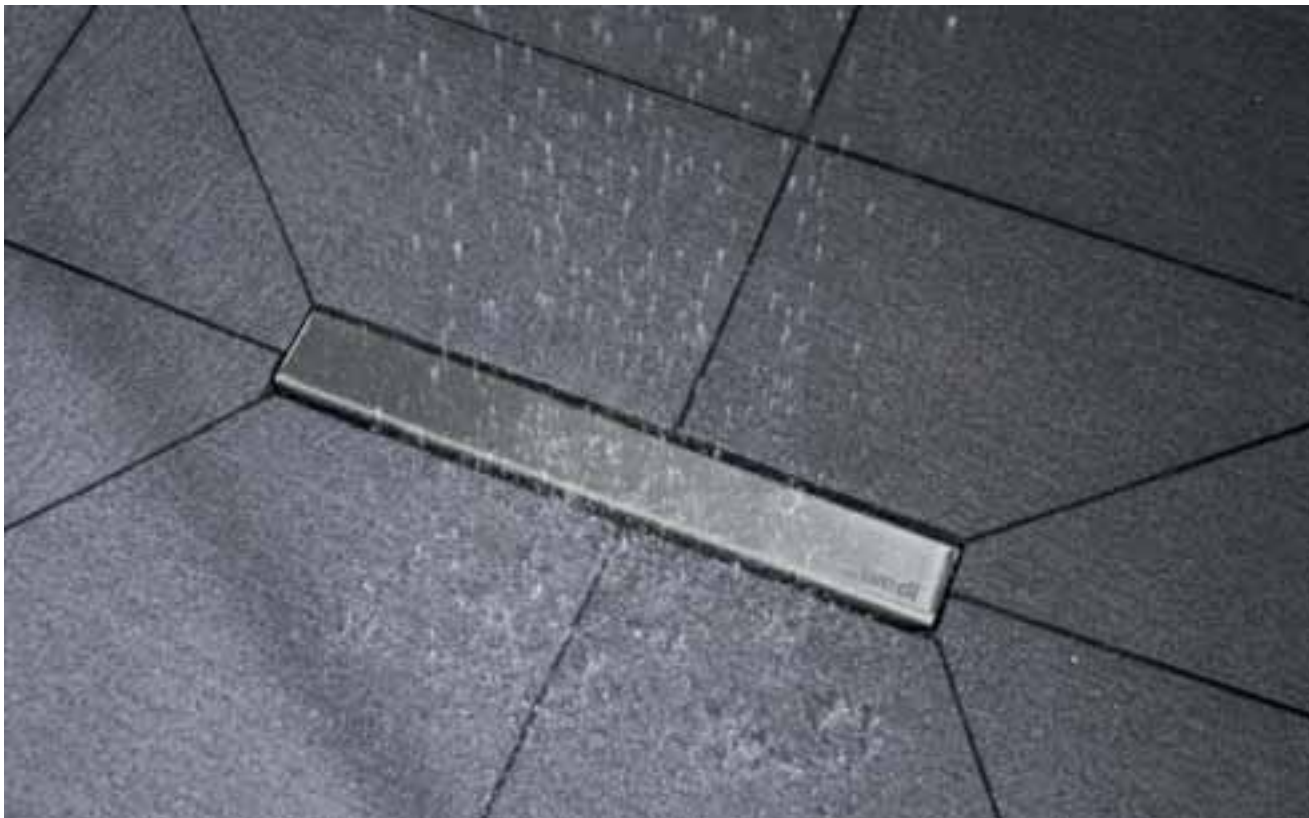

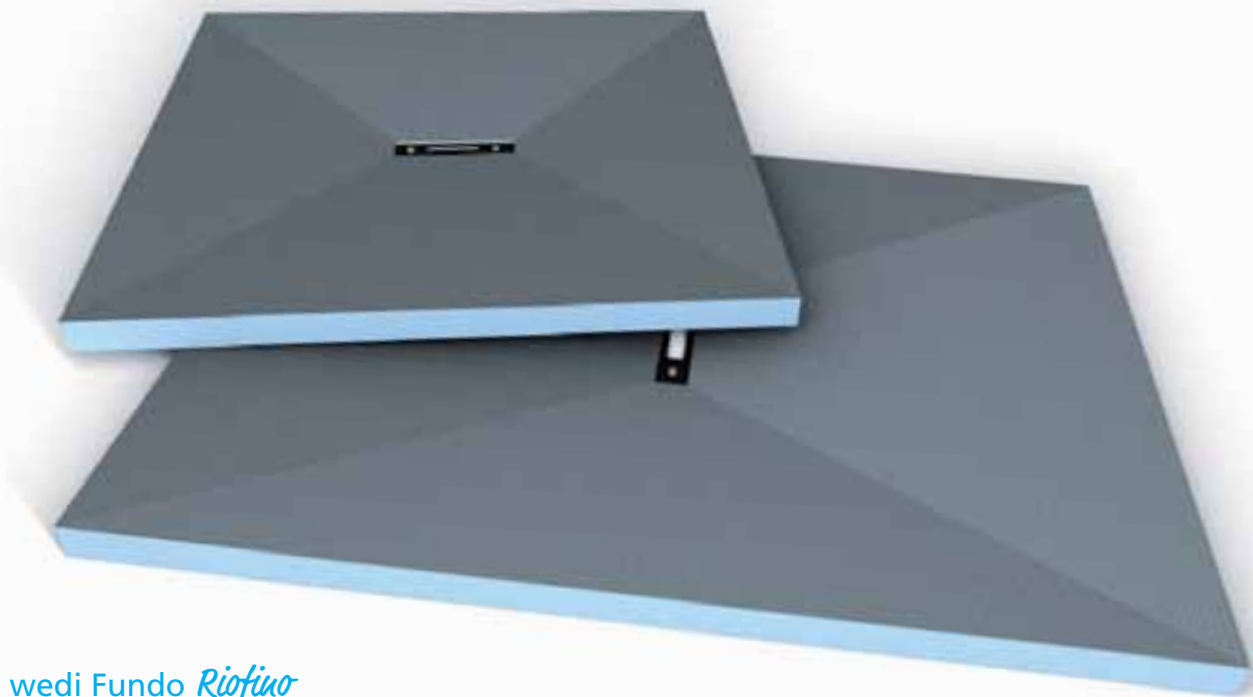

wedi Fundo *Riofino* and the right system components

+ wedi Fundo *Riolito/Riofino* drain

Thanks to the low installation height and waterproof security, the wedi drains are very well suited to new builds and renovations. There is a variety of different versions for vertical and horizontal designs.



+ wedi 610

As a versatile single-component adhesive and sealant, wedi 610 is particularly well suited to creating a waterproof joint between wedi components. The combination of wedi building board and wedi 610 has an abP general appraisal certificate for the heavy-duty area.

+ wedi Fundo sealing set

The sealing set to create a waterproof connection between wedi Fundo and wedi building boards or other materials not belonging to the system, e.g. screed, plasterboard, etc.



+ wedi *Tools* joint reinforcement tape

Special (self-adhesive) glass fibre mesh tape to fix and bridge the protruding edges of structural panels.



+ wedi Fundo *Riofino* drain covers

The high quality brushed stainless steel covers complete the design demand of the wedi Fundo *Riofino* floor elements.

Design versions: standard, exclusive and tileable



Drain versions Linear drainage

Fundo Riofino horizontal drain, DN 50, screed flooring

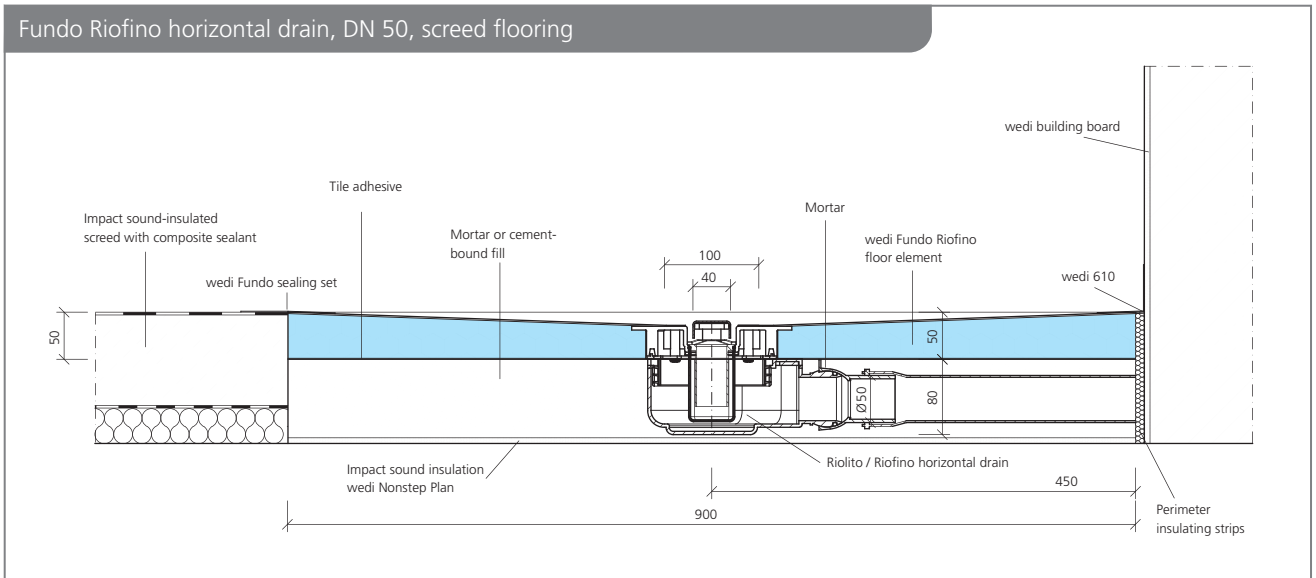

Fundo Riofino vertical drain, DN 50, screed flooring (also available with fire breakpoint)

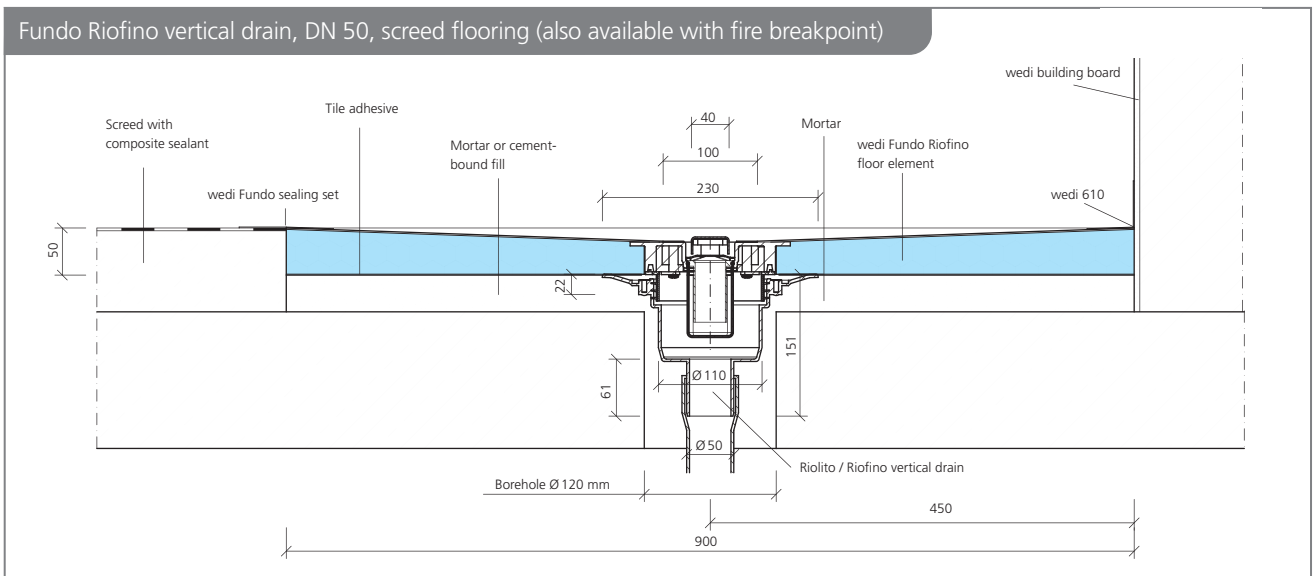

Fundo drain Riofino Mini Max, DN 40

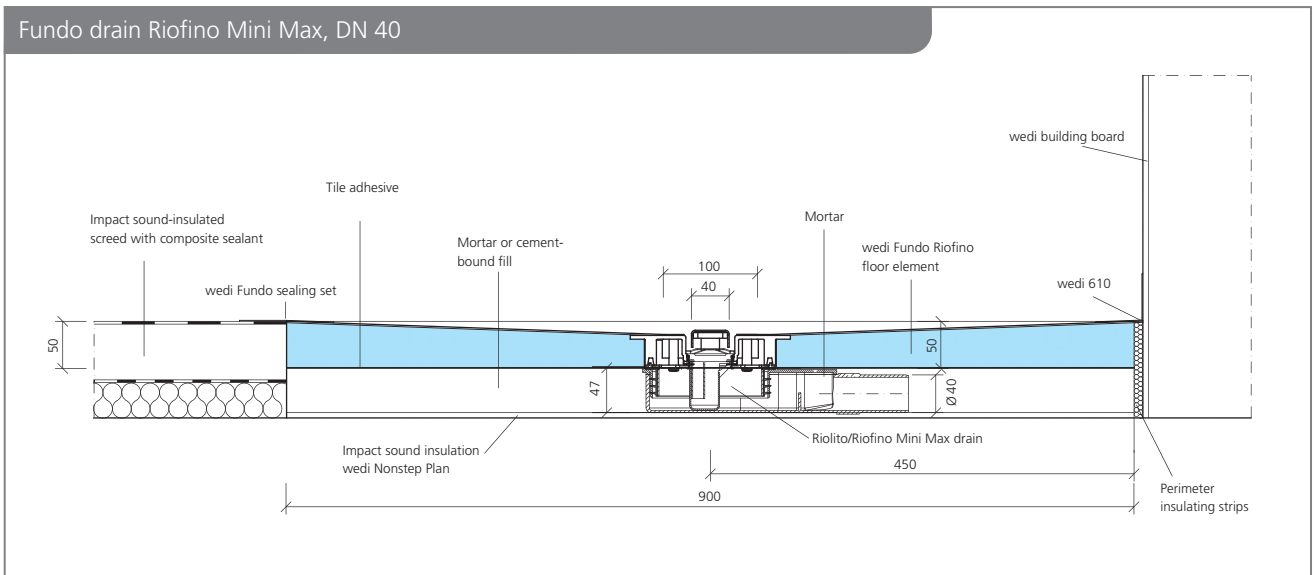

i You will find further technical drawings in the relevant assembly instructions and in the "Creation of flush-to-floor showers" brochure.

Item numbers and designs

1st selection: Floor element

	Length x width x thickness	Gutter length	Order no.
wedi Fundo Riofino, floor element with central channel drain, square	900 x 900 x 50 mm	300 mm	07-37-34/170
wedi Fundo Riofino, floor element with central channel drain, square	1000 x 1000 x 50 mm	300 mm	07-37-34/131
wedi Fundo Riofino, floor element with central channel drain, square	1200 x 1200 x 50 mm	300 mm	07-37-34/171
wedi Fundo Riofino, floor element with central channel drain, rectangular	1200 x 900 x 50 mm	300 mm	07-37-34/174
wedi Fundo Riofino, floor element with central channel drain, rectangular	1800 x 900 x 50 mm	300 mm	07-37-34/580

2nd selection: drain

	Packaging unit	Order no.
wedi Fundo Riolito / Riofino, vertical drain, DN 50, drainage capacity 1.12 l/s ; 67.2 l/min	1 unit	07-37-89/013
wedi Fundo Riolito / Riofino, vertical drain, DN 50 with fire protection collar, drainage capacity 1.12 l/s ; 67.2 l/min	1 unit	07-37-89/012
wedi Fundo Riolito / Riofino, horizontal drain, DN 50, drainage capacity 0.80 l/s ; 48.0 l/min	1 unit	07-37-90/004
wedi Fundo Riolito / Riofino Mini Max, drain, DN 40, extra-flat, drainage capacity 0.40 l/s ; 24 l/min	1 unit	07-37-90/006

3rd selection: Sealant

	Quantity / length x width	Packaging unit	Order no.
Version 1 – Installation in screed; no wall/floor connection with wedi building board			
wedi Fundo sealing set		1 pail	07-37-96/000
wedi Tools, sealing tape, fleece-lined	50 m x 100 mm	1 roll	09-51-00/352
wedi Tools, sealing tape, fleece-lined	10 m x 120 mm	1 roll	09-51-10/311
wedi Tools, sealing tape, fleece-lined	50 m x 120 mm	1 roll	09-51-10/352
wedi Tools, inside corners, fleece laminated	120 x 120 mm	25 units	09-51-30/001
wedi Tools, outside corners, fleece laminated	115 x 115 mm	25 units	09-51-35/001
Version 2 – Installation on the floor; connection to wall/floor with wedi building board			
wedi 610, adhesive sealant	310 ml / 1 cartridge	20 units	07-69-02/002
wedi Tools, joint reinforcement tape	25 m x 125 mm	1 roll	09-52-20/053
wedi Tools, joint reinforcement tape, self-adhesive	25 m x 125 mm	1 roll	09-52-25/053

4th selection: linear channel covers

	Length x width x thickness	Packaging unit	Order no.
wedi Fundo Riolito/Riofino linear channel cover standard, stainless steel in 1.5 mm thickness, brushed	300 x 40 x 18 mm	1 unit	67-67-97/013
wedi Fundo Riolito/Riofino linear channel cover exclusive, solid stainless steel in 1.5 mm thickness, brushed	300 x 40 x 21 mm	1 unit	67-67-97/004
wedi Fundo Riolito/Riofino linear channel cover tileable, stainless steel	300 x 40 x 18 mm	1 unit	67-67-97/014



You can find countless expansion options for your shower or complete bathroom conversion in the wedi product range.



All installation instructions can be found using this QR code.





A total installation height
of just 70 mm

wedi Fundo *Plauo Linea*

The thinnest complete linear system

wedi's innovation of the year is the thinnest complete system for floor-level showers featuring linear drainage. With the drain technology, which is integrated in the factory, the system measures a mere 70 mm and is a special wedi highlight in bathroom renovations. Positioned very close to the wall, and featuring a short or long channel as an option, the drain gives a high-quality impression from a visual perspective and also frees up additional space for pure shower enjoyment.



Extremely flat: a total installation height of just 70 mm



Complete system incl. integrated drain technology



Linear drainage especially close to the wall

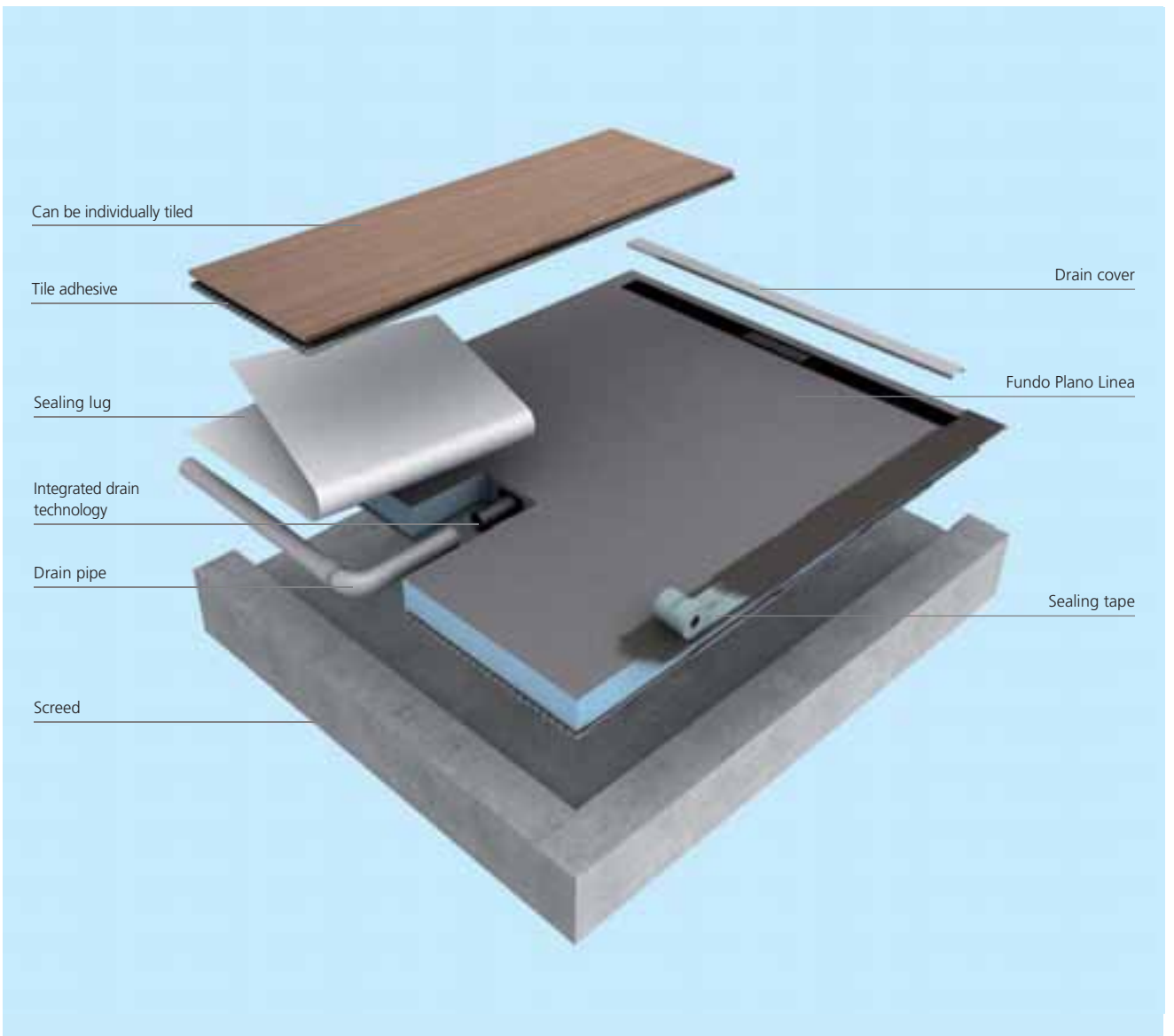

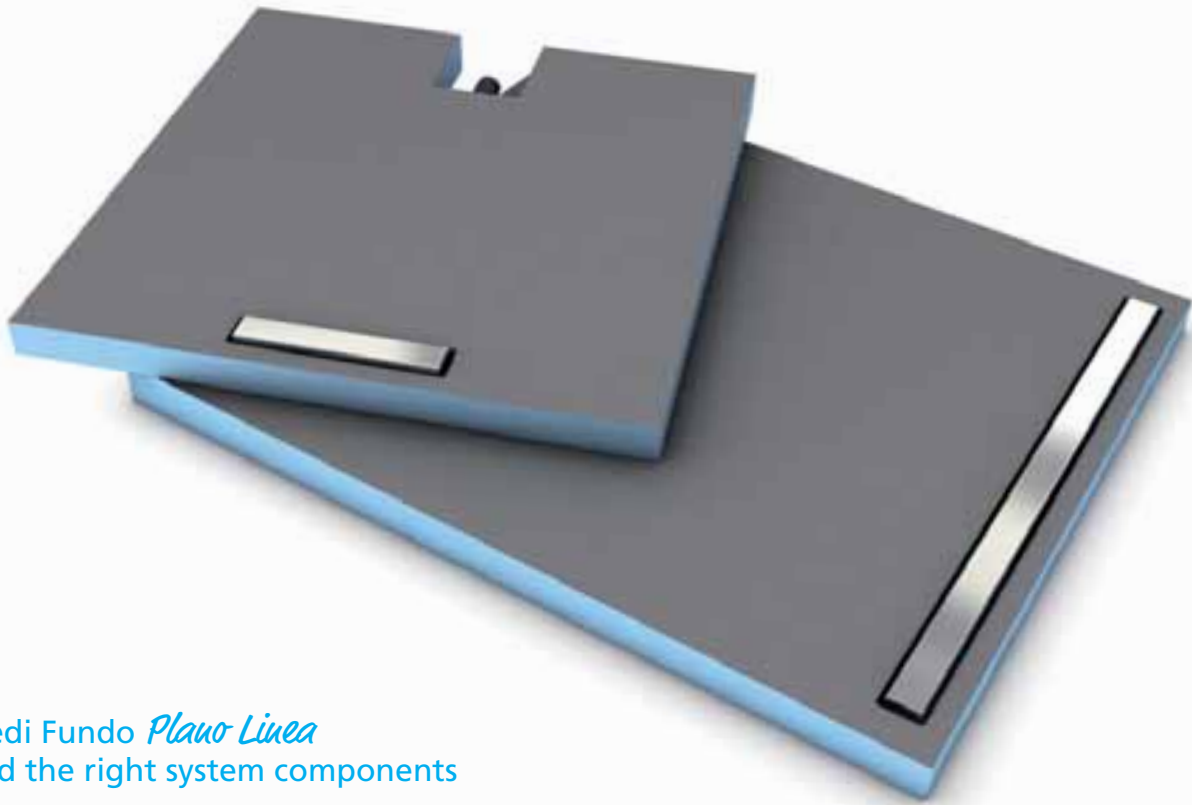

wedi Fundo *Plano Linea*
and the right system components

+ wedi 610

As a versatile single-component adhesive and sealant, wedi 610 is particularly well suited to creating a waterproof joint between wedi components. The combination of wedi building board and wedi 610 has an abP general appraisal certificate for the heavy-duty area.



+ wedi Fundo sealing set

The sealing set to create a waterproof connection between wedi Fundo and wedi building boards or other materials not belonging to the system, e.g. screed, plasterboard, etc.



Scope of delivery:

wedi Fundo Plano Linea already has a DN 40 horizontal drain permanently integrated into the floor element. The scope of delivery also includes a height adjustable V₂A brushed stainless steel cover and a large sealing pad.



Drain versions Special solutions

Fundo Plano Linea, integrated horizontal drain, DN 40, screed flooring

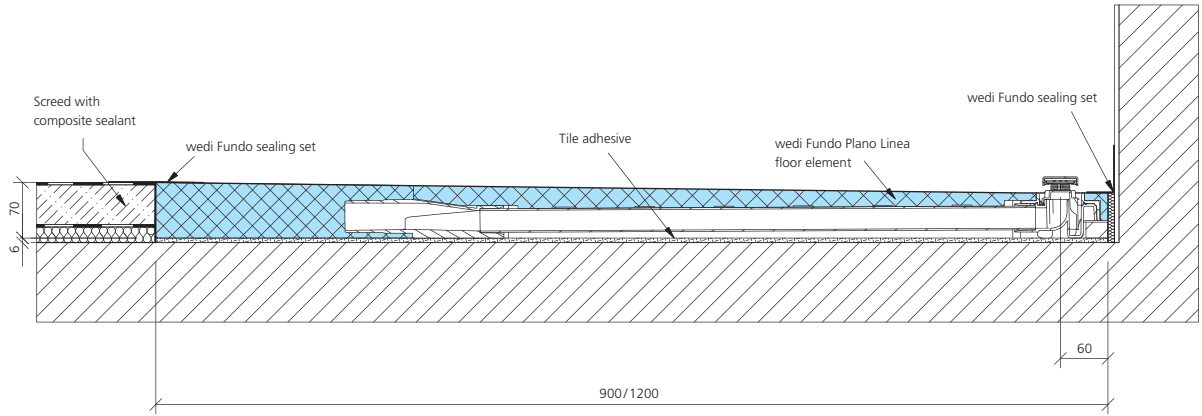

Fundo Plano Linea, floor element with channel

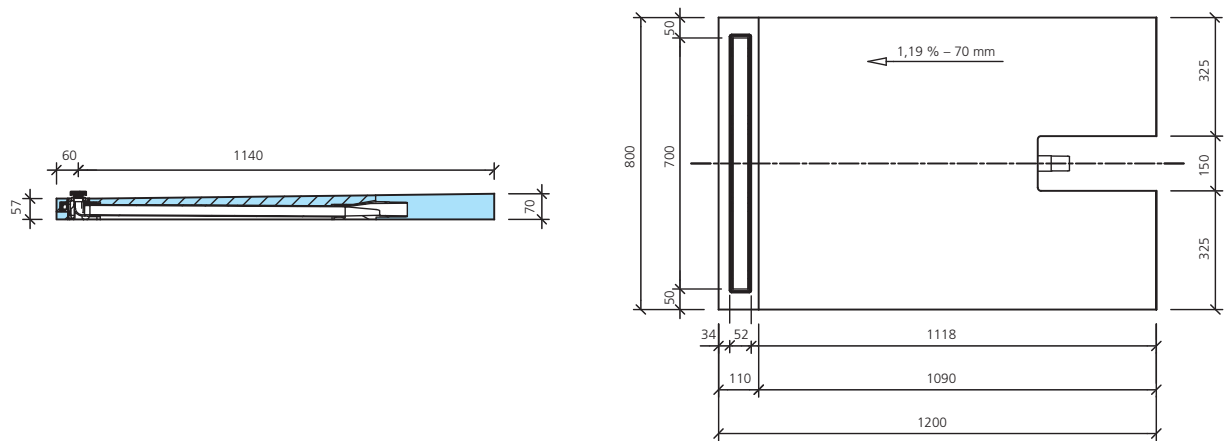

Fundo Plano Linea, floor element with short channel

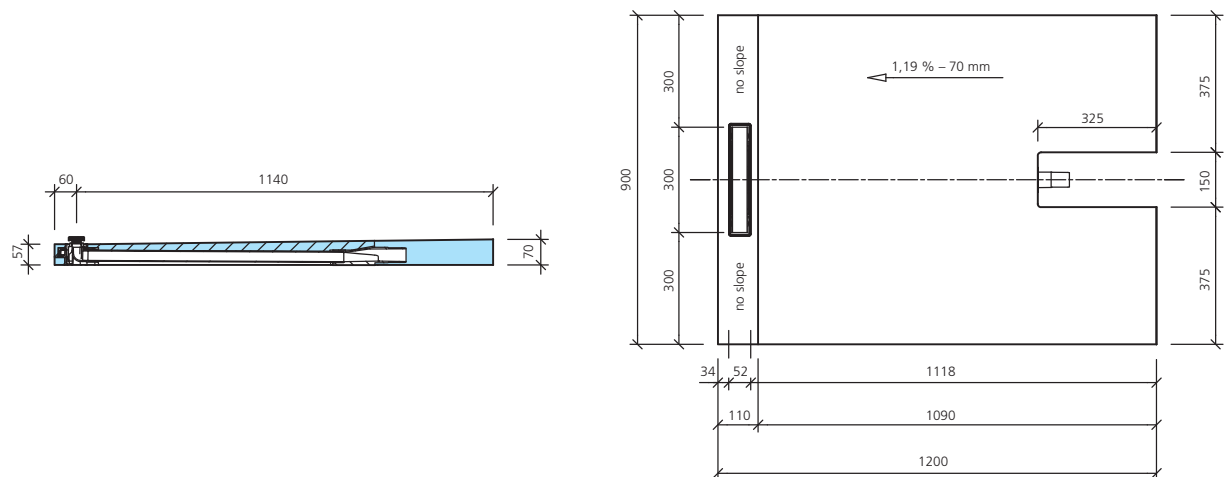

i You will find further technical drawings in the relevant assembly instructions and in the "Creation of flush-to-floor showers" brochure.

Item numbers and designs

1st selection: Floor element

	Length x width x thickness	Gutter length	Order no.
wedi Fundo Plano Linea, floor element with channel and fully integrated drain technology, rectangular	1200 x 800 x 70 mm	700 mm	07-37-36/600
wedi Fundo Plano Linea, floor element with channel and fully integrated drain technology, rectangular	1200 x 900 x 70 mm	800 mm	07-37-36/601
wedi Fundo Plano Linea, floor element with short channel and fully integrated drain technology, rectangular	1200 x 900 x 70 mm	300 mm	07-37-36/607
wedi Fundo Plano Linea, floor element with channel and fully integrated drain technology, rectangular	1200 x 1000 x 70 mm	900 mm	07-37-36/602
wedi Fundo Plano Linea, floor element with channel and fully integrated drain technology, square	900 x 900 x 70 mm	800 mm	07-37-36/603
wedi Fundo Plano Linea, floor element with short channel and fully integrated drain technology, square	900 x 900 x 70 mm	300 mm	07-37-36/608

2nd selection: Sealant

	Quantity / length x width	Packaging unit	Order no.
Version 1 – Installation in screed; no wall/floor connection with wedi building board			
wedi Fundo sealing set		1 pail	07-37-96/000
wedi Tools, sealing tape, fleece-lined	50 m x 100 mm	1 roll	09-51-00/352
wedi Tools, sealing tape, fleece-lined	10 m x 120 mm	1 roll	09-51-10/311
wedi Tools, sealing tape, fleece-lined	50 m x 120 mm	1 roll	09-51-10/352
wedi Tools, inside corners, fleece laminated	120 x 120 mm	25 units	09-51-30/001
wedi Tools, outside corners, fleece laminated	115 x 115 mm	25 units	09-51-35/001
Version 2 – Installation on the floor; connection to wall/floor with wedi building board			
wedi 610, adhesive sealant	310 ml / 1 cartridge	20 units	07-69-02/002
wedi Tools, joint reinforcement tape	25 m x 125 mm	1 roll	09-52-20/053
wedi Tools, joint reinforcement tape, self-adhesive	25 m x 125 mm	1 roll	09-52-25/053



You can find countless expansion options for your shower or complete bathroom conversion in the wedi product range.



All installation instructions can be found using this QR code.



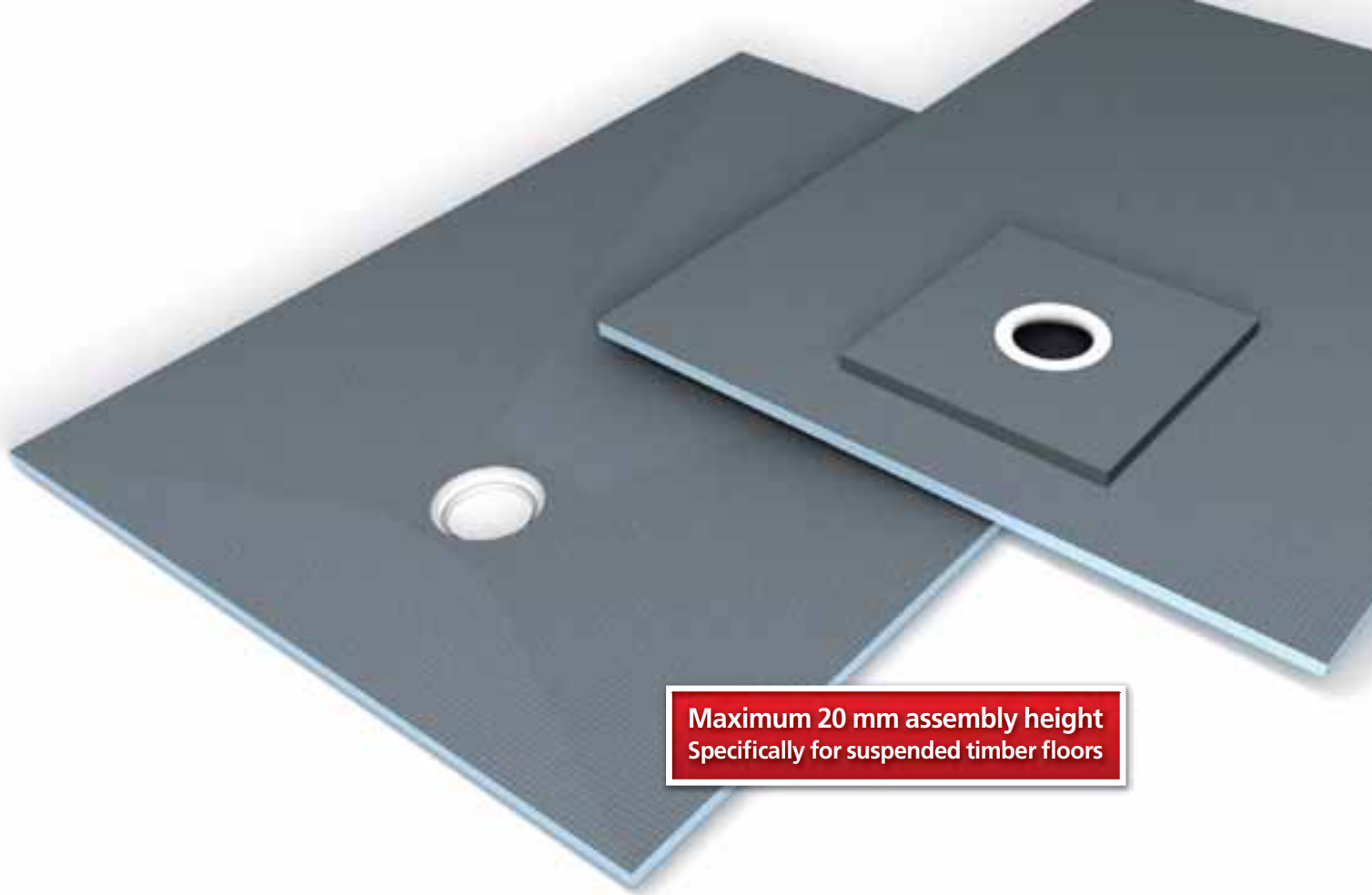

wedi Fundo *Liquo*

Flush-to-floor shower element for suspended timber floors

The flush-to-floor shower element, which is just 20 mm thick on the outer edge, has been developed especially for use in old and new buildings with timber joist floors. In comparison to conventional shower elements, the Fundo Ligno is adapted to the wooden layer of the floor, meaning it can be integrated wonderfully into this – without creating further height and without any laborious levelling measures.



Especially for timber
joist floors



Decoupling
effect



Can be combined with
all Fundo drains



Integrated processing at the same height as the timber beam floor

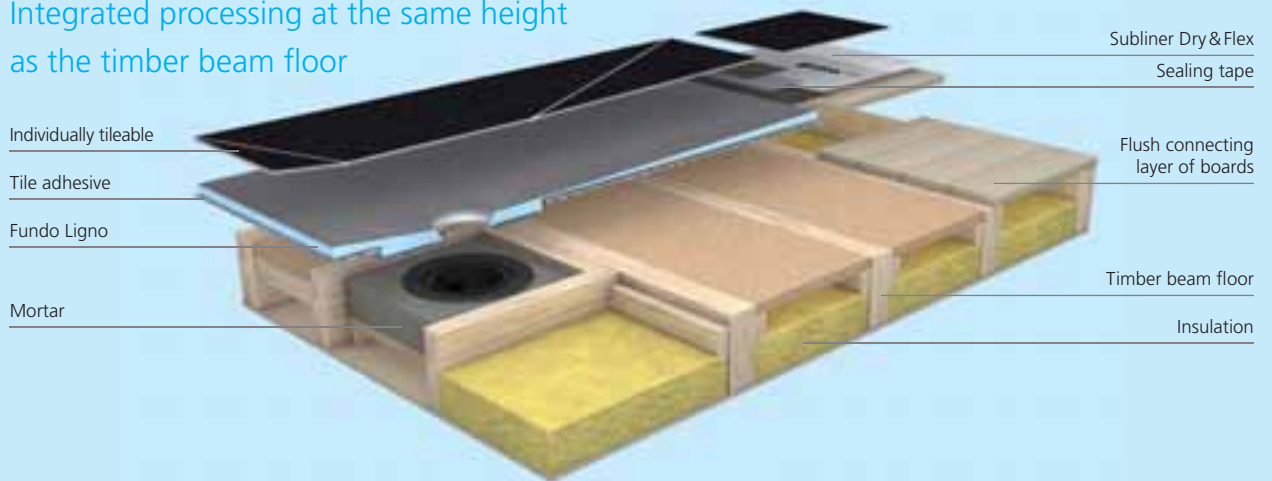

Processed on the timber beam floor with connection of the building board

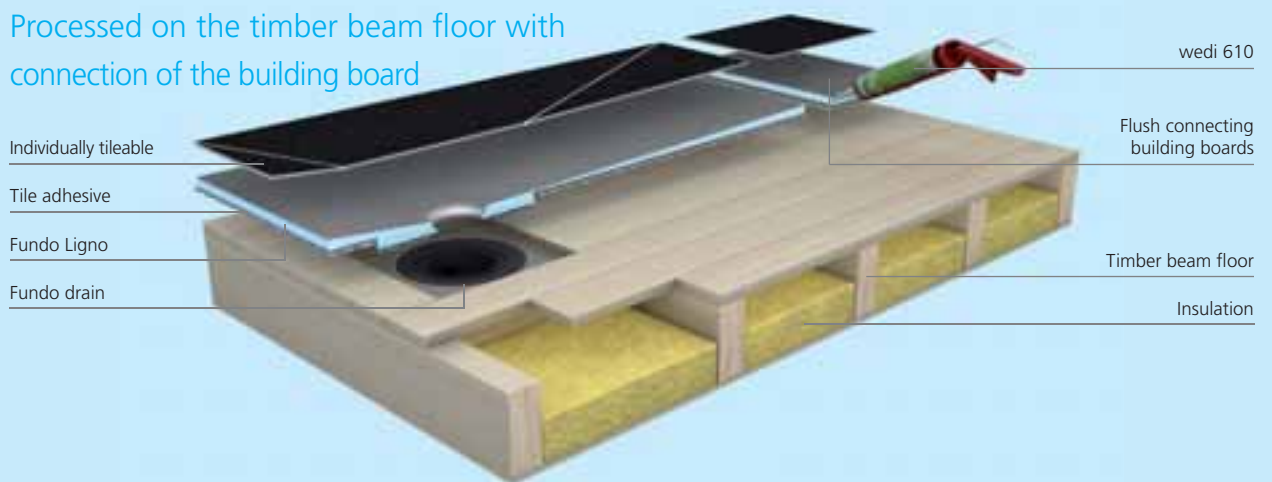

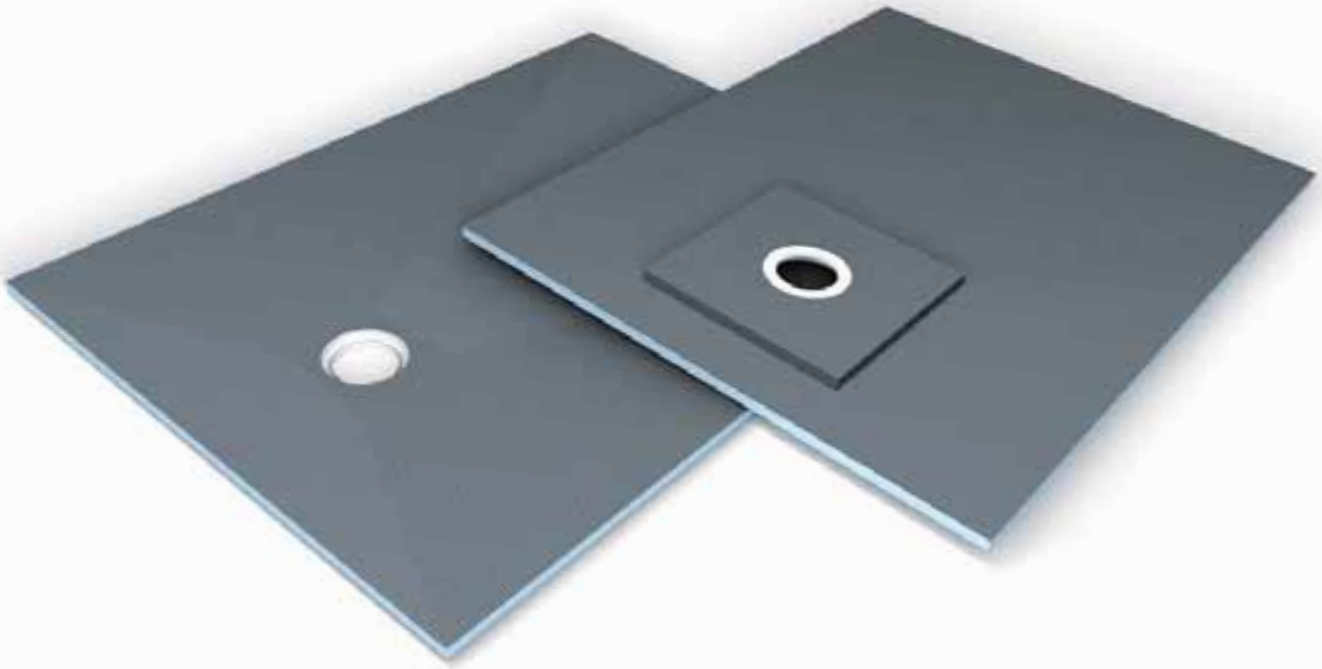

wedi Fundo *Liquo* and the right system components

+ wedi 610

As a versatile single-component adhesive and sealant, wedi 610 is particularly well suited to creating a waterproof joint between wedi components. The combination of wedi building board and wedi 610 has an abP general appraisal certificate for the heavy-duty area.



+ wedi *Tools* joint reinforcement tape

Special (self-adhesive) glass fibre mesh tape to fix and bridge the protruding edges of structural panels.



+ wedi Fundo sealing set

The sealing set to create a waterproof connection between wedi Fundo and wedi building boards or other materials not belonging to the system, e.g. screed, plasterboard, etc.



+ wedi *Subliner Dry & Flex*

Flexible, crack-bridging sealant and decoupling roll made of ultra tear-resistant polyethylene foil for indoor and outdoor walls and floors. A0 and B0 areas of application.



+ wedi Fundo drain

Thanks to the low installation height and waterproof security, the wedi drains are very well suited to new builds and renovations. There is a variety of different versions for vertical and horizontal designs.



Drain versions Special solutions

Fundo horizontal drain, DN 50, in timber beam floor

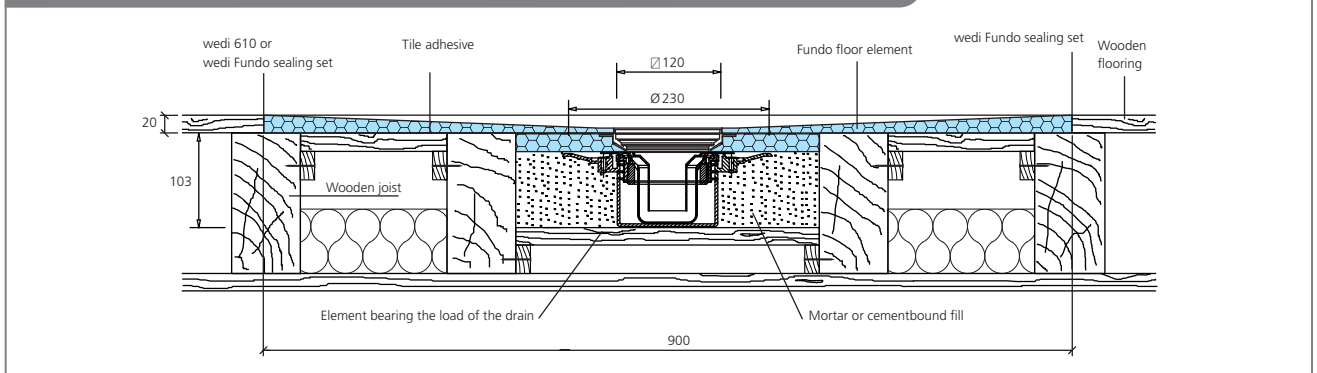

Fundo horizontal drain, DN 50, on timber beam floor

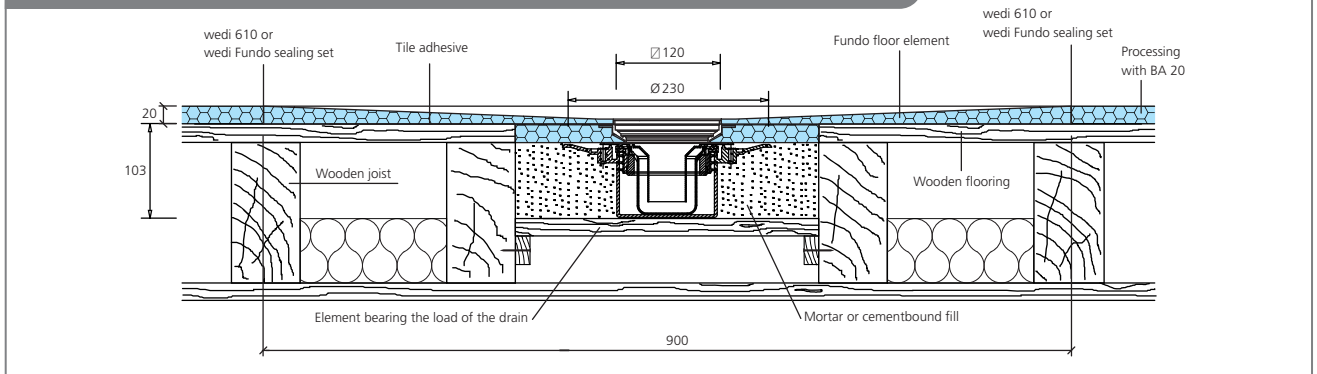

Fundo drain Mini Max, DN 40, in timber beam floor

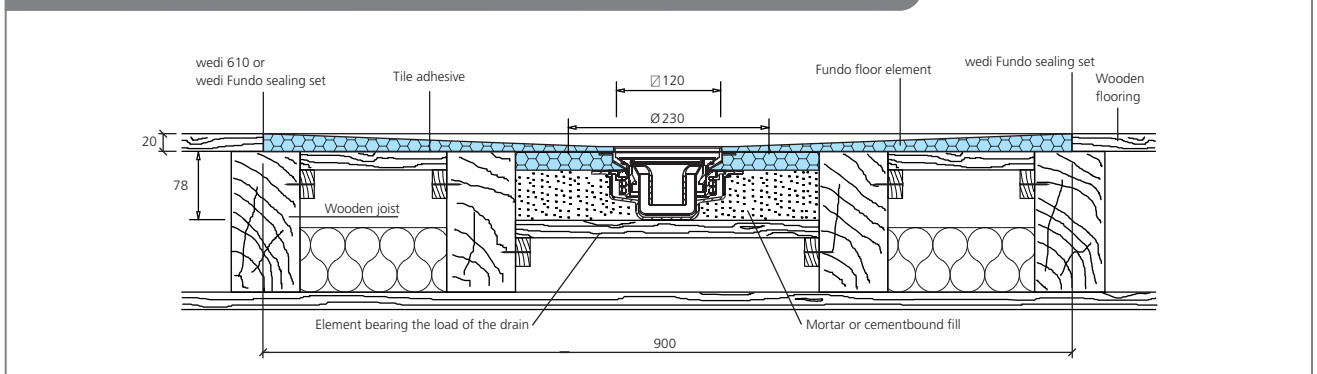

Fundo drain Mini Max, DN 40, on timber beam floor

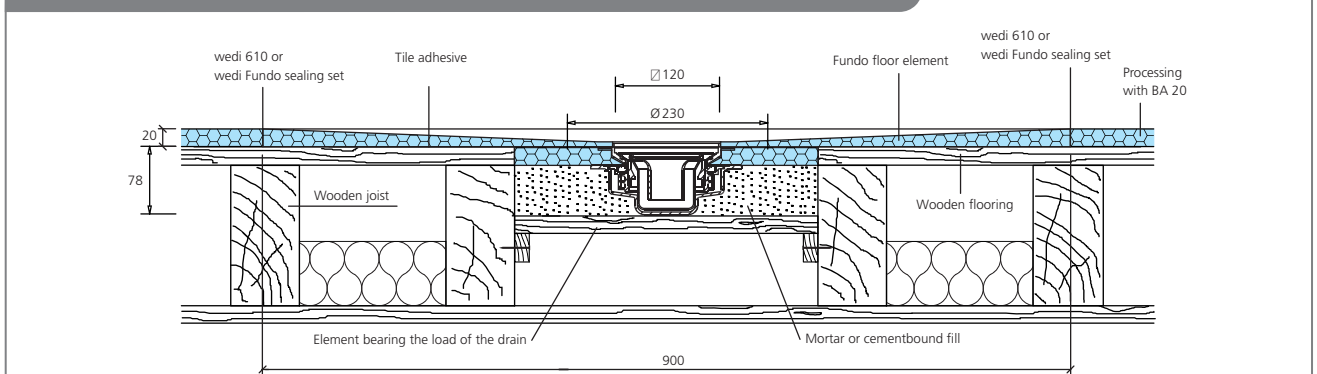

i You will find further technical drawings in the relevant assembly instructions and in the "Creation of flush-to-floor showers" brochure.

Item numbers and designs

1st selection: Floor element

	Length x width x thickness	Packaging unit	Order no.
wedi Fundo Ligno, square floor element, central drain	900 x 900 x 20/41 mm	10 units	07-37-32/011
wedi Fundo Ligno, square floor element, central drain	1200 x 1200 x 20/41 mm	10 units	07-37-32/012
wedi Fundo Ligno, square floor element, central drain	1500 x 1500 x 20/41 mm	10 units	07-37-32/013
wedi Fundo Ligno, square floor element, corner drain	900 x 900 x 20/41 mm	10 units	07-37-32/021
wedi Fundo Ligno, square floor element, corner drain	1200 x 1200 x 20/41 mm	10 units	07-37-32/023
wedi Fundo Ligno, rectangular floor element, offset drain	1200 x 900 x 20/41 mm	10 units	07-37-32/022
wedi Fundo Ligno, rectangular floor element, offset drain	1600 x 900 x 20/41 mm	10 units	07-37-32/024

2nd selection: Drain

	Packaging unit	Order no.
wedi Fundo vertical drain, DN 50, square, drainage capacity 1.00 l/s ; 60.0 l/min	1 unit	07-70-00/007
wedi Fundo vertical drain, DN 50, round, drainage capacity 1.00 l/s ; 60.0 l/min	1 unit	07-70-00/008
wedi Fundo vertical drain, DN 50, with fire protection collar, drainage capacity 1.00 l/s ; 60.0 l/min	1 unit	07-37-49/002
wedi Fundo vertical drain, DN 70, drainage capacity 0.88 l/s ; 52.8 l/min	1 unit	07-70-00/010
wedi Fundo horizontal drain, DN 50, square, drainage capacity 0.80 l/s ; 48.0 l/min	1 unit	07-70-00/011
wedi Fundo horizontal drain, DN 50, round, drainage capacity 0.80 l/s ; 48.0 l/min	1 unit	07-70-00/012
wedi Fundo drain Mini Max, DN 40, extra-flat, drainage capacity 0.54 l/s ; 32.4 l/min	1 unit	07-70-00/015

3rd selection: Sealant

	Quantity / length x width	Packaging unit	Order no.
Version 1 – Installation in screed; no wall/floor connection with wedi building board			
wedi Fundo sealing set		1 pail	07-37-96/000
wedi Subliner Dry, sealing membrane	30 m x 1 m	40 rolls	09-51-10/332
wedi Subliner Dry, sealing membrane	5 m x 1 m	96 rolls	09-51-10/305
wedi Subliner Flex, decoupling membrane	30 m x 1 m	18 rolls	09-51-10/331
wedi Subliner Dry & Flex, sealing and decoupling membrane	15 m x 1 m	36 rolls	09-51-10/315
Version 2 – Installation on the floor; connection to wall/floor with wedi building board			
wedi 610, adhesive sealant	310 ml / 1 cartridge	20 units	07-69-02/002
wedi Tools, joint reinforcement tape	25 m x 125 mm	1 roll	09-52-20/053
wedi Tools, joint reinforcement tape, self-adhesive	25 m x 125 mm	1 roll	09-52-25/053



You can find countless expansion options for your shower or complete bathroom conversion in the wedi product range.



All installation instructions can be found using this QR code.







With a total installation height of just 65 mm

wedi Fundo *Plauo*

The thinnest complete system for flush-to-floor showers on the market

With the pre-integrated drain, the total system is just 65 mm flat. This innovation is second to none when it comes to renovations, where every millimetre counts. The product naturally offers all the advantages of the wedi products, which have been tried and tested for more than 30 years – from the guaranteed 100% watertightness through to its versatile and easily implemented usage. Renovation in perfection.

 Integrated drain for rapid processing

 Entire system is 100% watertight

 Extremely flat, ideal for renovations

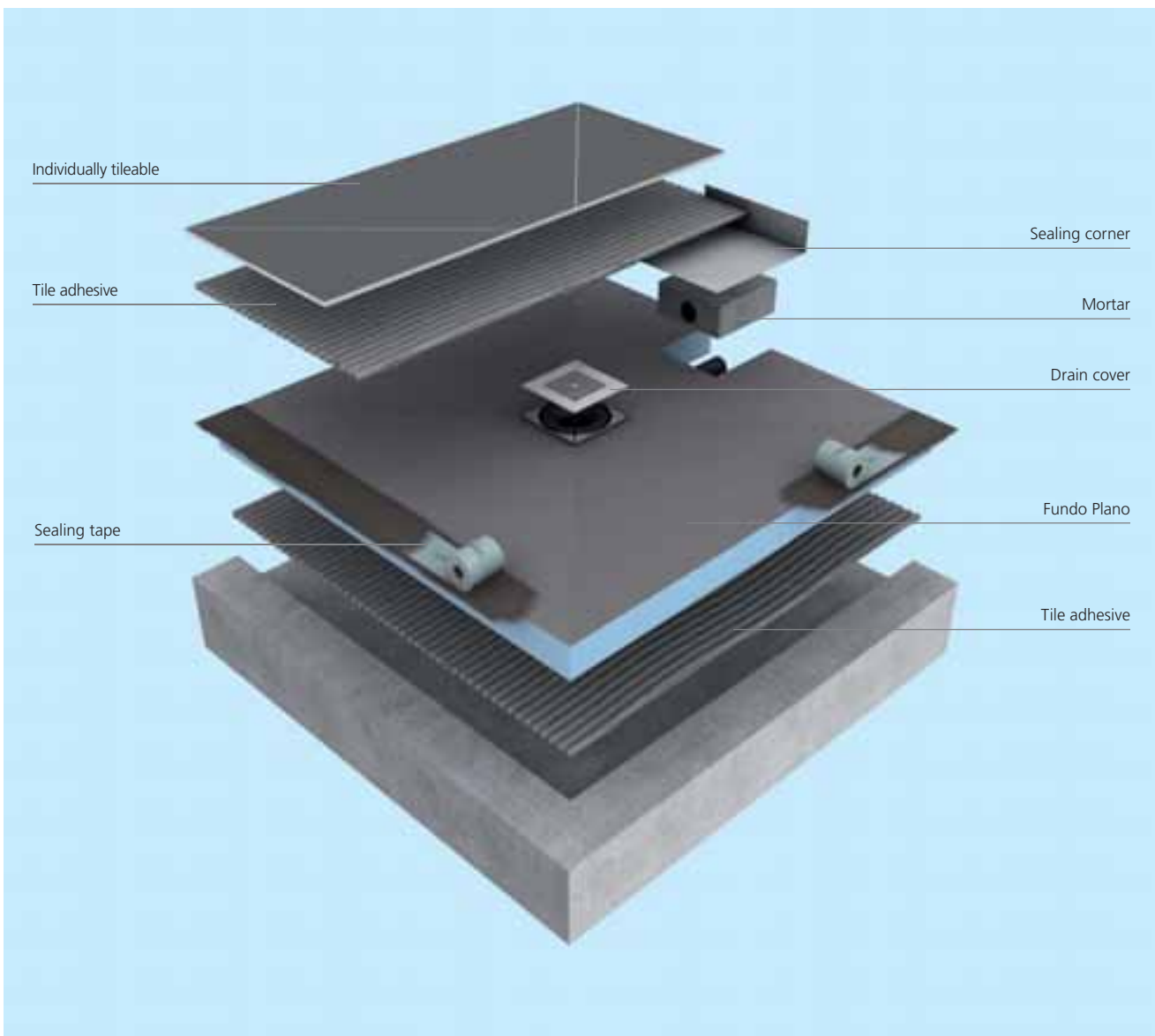

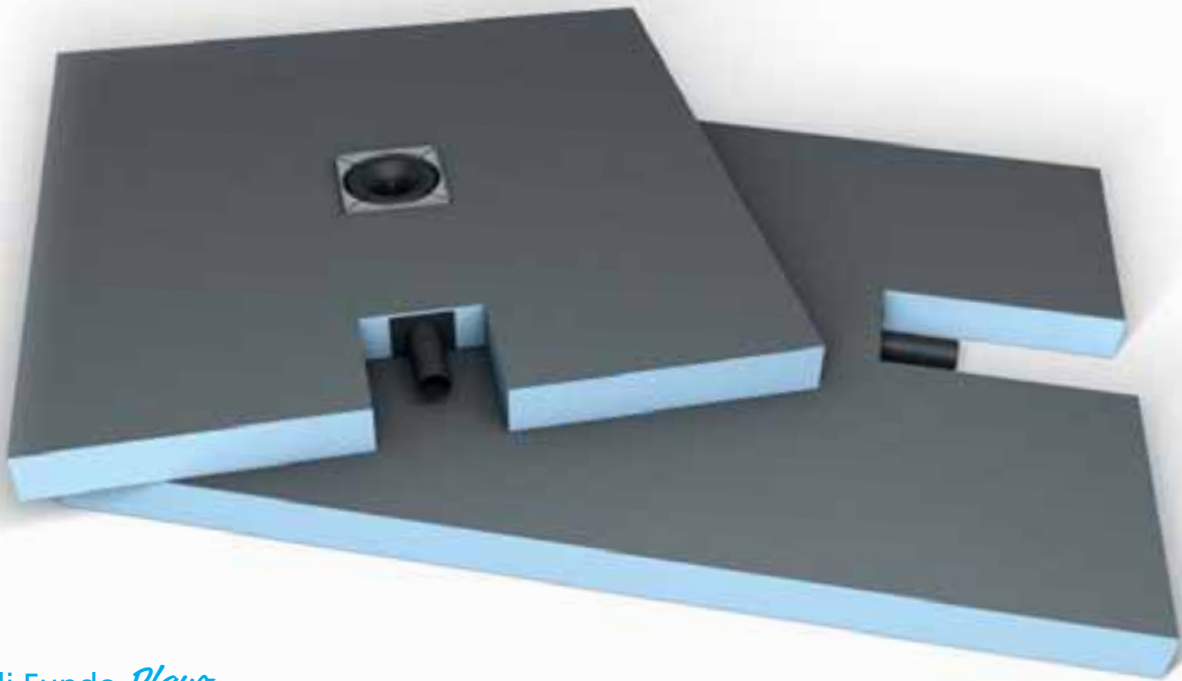

wedi Fundo *Plano* and the right system components

+ wedi Fundo sealing set

The sealing set to create a waterproof connection between wedi Fundo and wedi building boards or other materials not belonging to the system, e.g. screed, plasterboard, etc.



+ wedi 610

As a versatile single-component adhesive and sealant, wedi 610 is particularly well suited to creating a waterproof joint between wedi components. The combination of wedi building board and wedi 610 has an abP general appraisal certificate for the heavy-duty area.



Scope of delivery:

wedi Fundo Plano has a horizontal drain DN 40 which is already integrated into the floor element. In addition, the product is also supplied with a brushed stainless steel V₂A drain cover including a frame extension and a sealing corner.

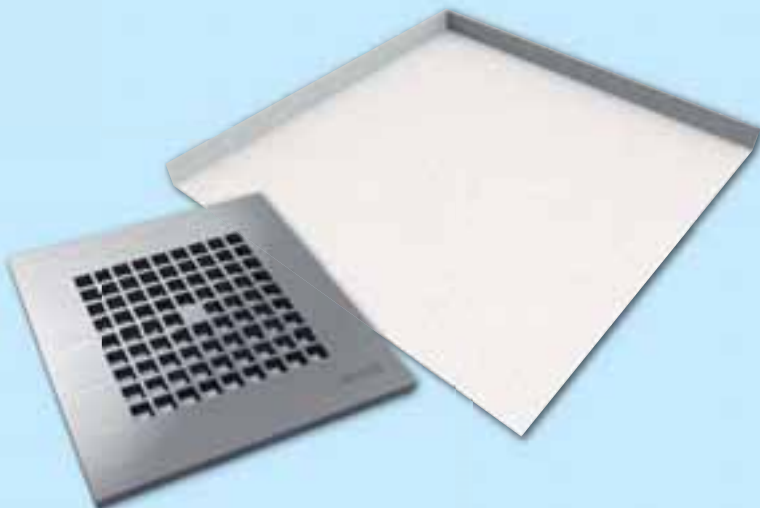

Drain versions Special solutions

Fundo Plano, integrated horizontal drain, DN 40, screed flooring

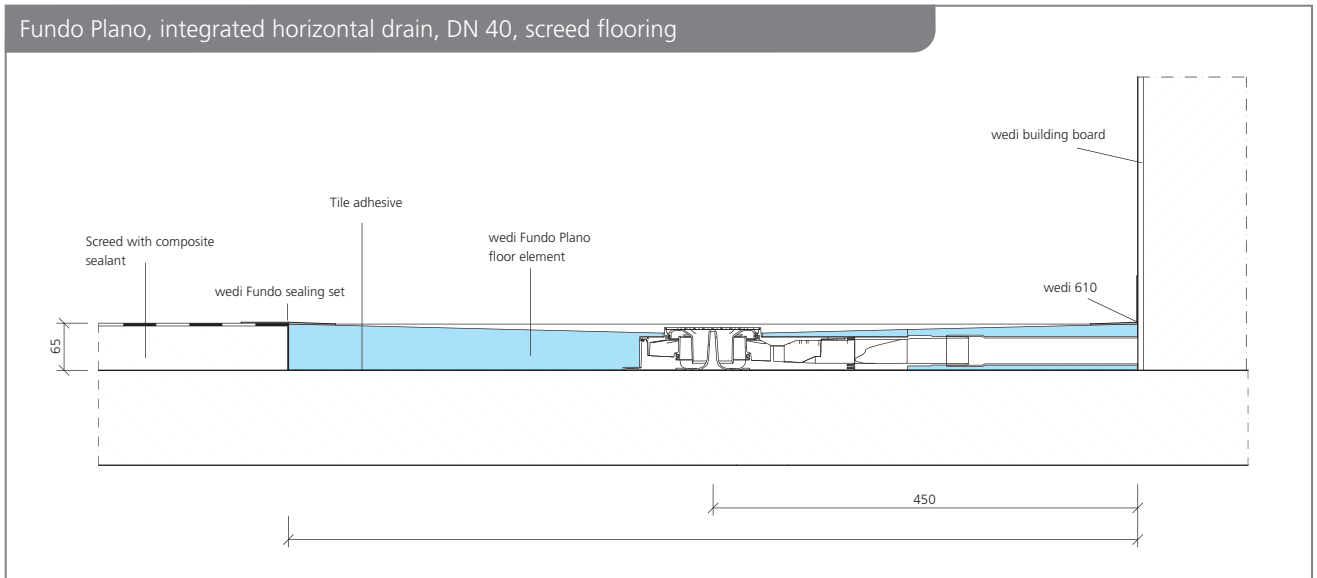

Fundo Plano, complete system A, connection on the long side

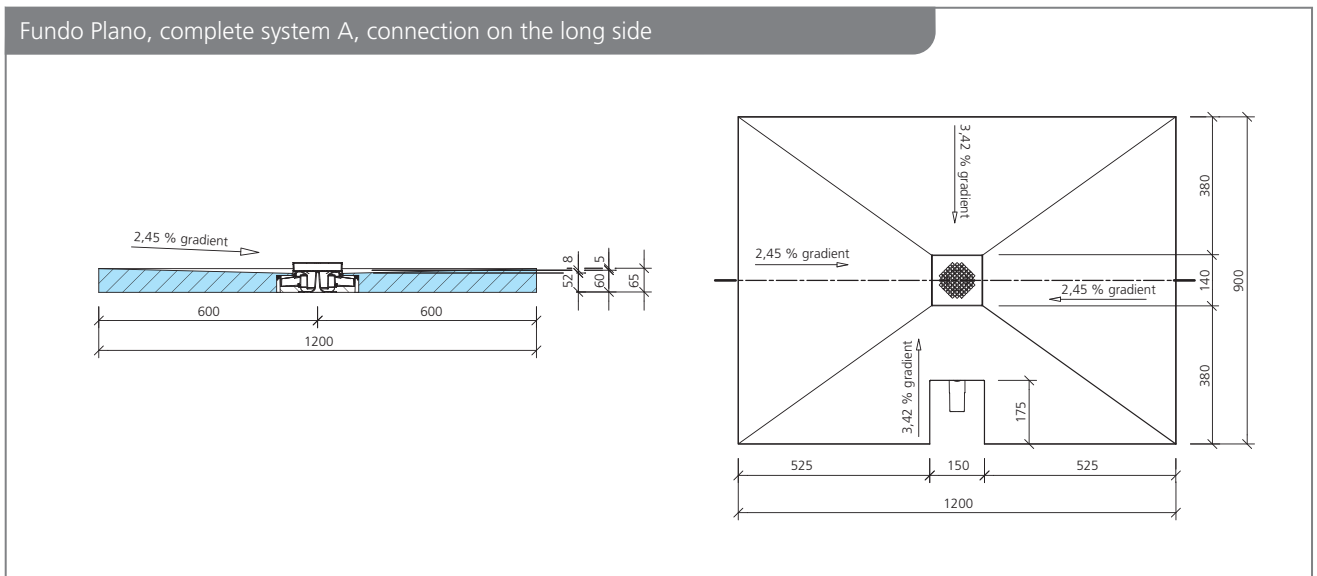

Fundo Plano, complete system B, connection on the short side

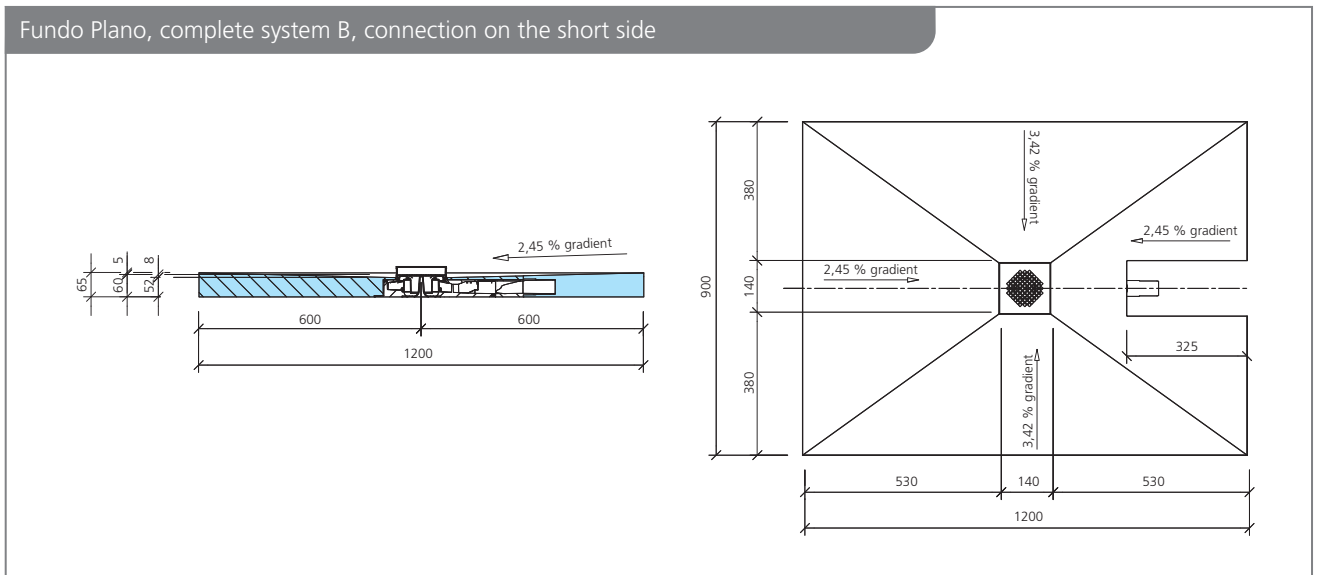

i You will find further technical drawings in the relevant assembly instructions and in the "Creation of flush-to-floor showers" brochure.

Item numbers and designs

1st selection: Floor element

	Length x width x thickness	Packaging unit	Order no.
wedi Fundo Plano, complete system incl. drainage technology, central drain, DN 40	900 x 900 x 65 mm	10 units	07-37-35/600
wedi Fundo Plano, complete system incl. drainage technology, central drain, DN 40	1000 x 1000 x 65 mm	10 units	07-37-35/601
wedi Fundo Plano, complete system incl. drainage technology, central drain, DN 40	1200 x 1200 x 65 mm	10 units	07-37-35/602
wedi Fundo Plano, complete system incl. drainage technology, central drain, DN 40	1200 x 900 x 65 mm	10 units	07-37-35/603
wedi Fundo Plano, complete system incl. drainage technology, central drain, DN 40, connection on the short side	1200 x 900 x 65 mm	10 units	07-37-35/604
wedi Fundo Plano, complete system incl. drainage technology, offset drain, DN 40, connection on the short side	1400 x 900 x 65 mm	10 units	07-37-35/605
wedi Fundo Plano, complete system incl. drainage technology, offset drain, DN 40, connection on the short side	1600 x 1000 x 65 mm	10 units	07-37-35/606

2nd selection: Sealant

	Quantity / length x width	Packaging unit	Order no.
Version 1 – Installation in screed; no wall/floor connection with wedi building board			
wedi Fundo sealing set		1 pail	07-37-96/000
wedi Tools, sealing tape, fleece-lined	50 m x 100 mm	1 roll	09-51-00/352
wedi Tools, sealing tape, fleece-lined	10 m x 120 mm	1 roll	09-51-10/311
wedi Tools, sealing tape, fleece-lined	50 m x 120 mm	1 roll	09-51-10/352
wedi Tools, inside corners, fleece laminated	120 x 120 mm	25 units	09-51-30/001
wedi Tools, outside corners, fleece laminated	115 x 115 mm	25 units	09-51-35/001
Version 2 – Installation on the floor; connection to wall/floor with wedi building board			
wedi 610, adhesive sealant	310 ml / 1 cartridge	20 units	07-69-02/002
wedi Tools, joint reinforcement tape	25 m x 125 mm	1 roll	09-52-20/053
wedi Tools, joint reinforcement tape, self-adhesive	25 m x 125 mm	1 roll	09-52-25/053



You can find countless expansion options for your shower or complete bathroom conversion in the wedi product range.



All installation instructions can be found using this QR code.



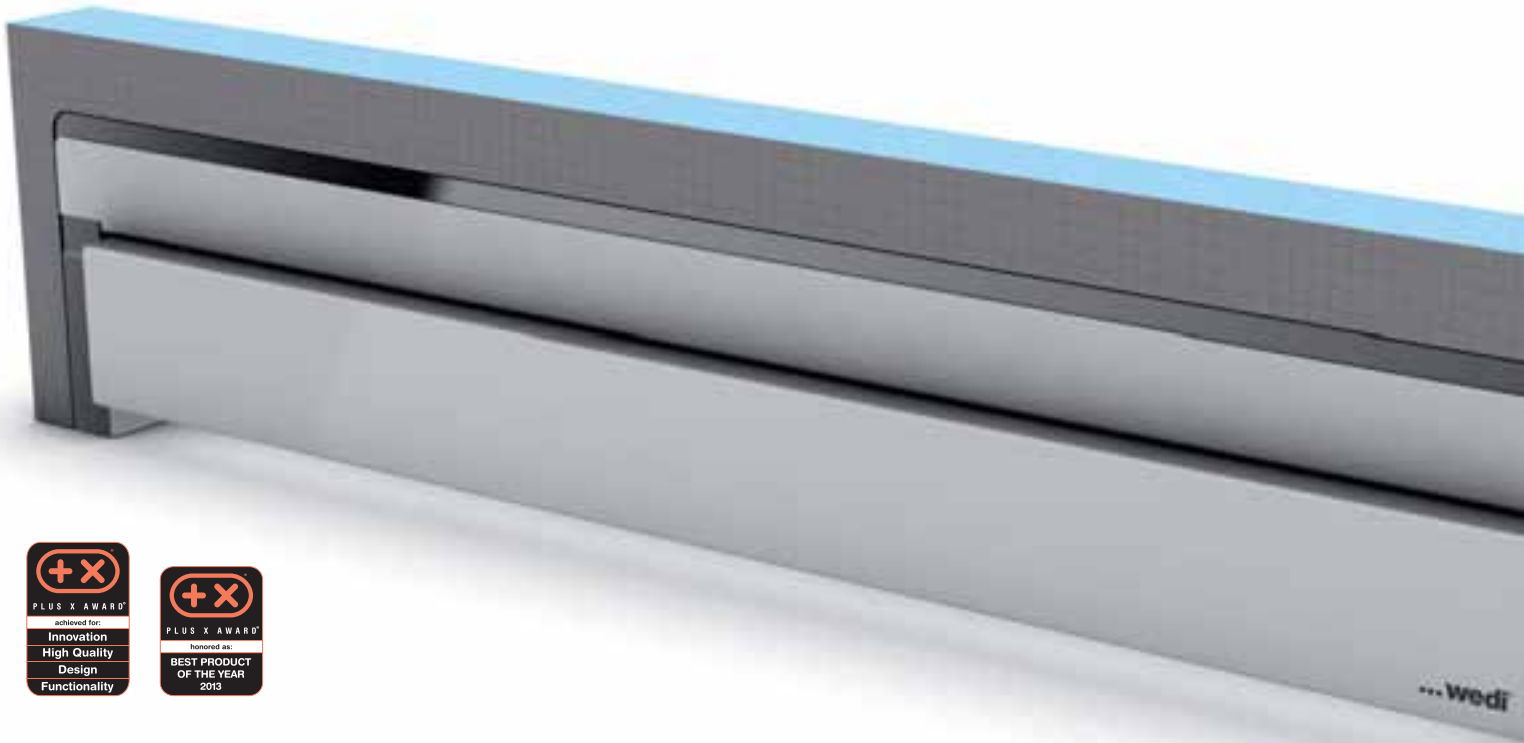

wedi Fundo *Riolito Discreto*

Optical wall drain with all the advantages of a classic floor drain

Contemporary design and completely new design options. The absolutely innovative Fundo Riolito Discreto literally tops the tried and tested Riolito. As a simple fixture, this clever innovation creates the illusion of a wall drain. The fixture can be easily incorporated in all wet room scenarios. Whether as a seat, shelf or a complete false wall - there are no limits to the design ideas with this system component.



Attractive wall drain through practical fixture module



Use of both sides of the cover possible: stainless steel or tiles

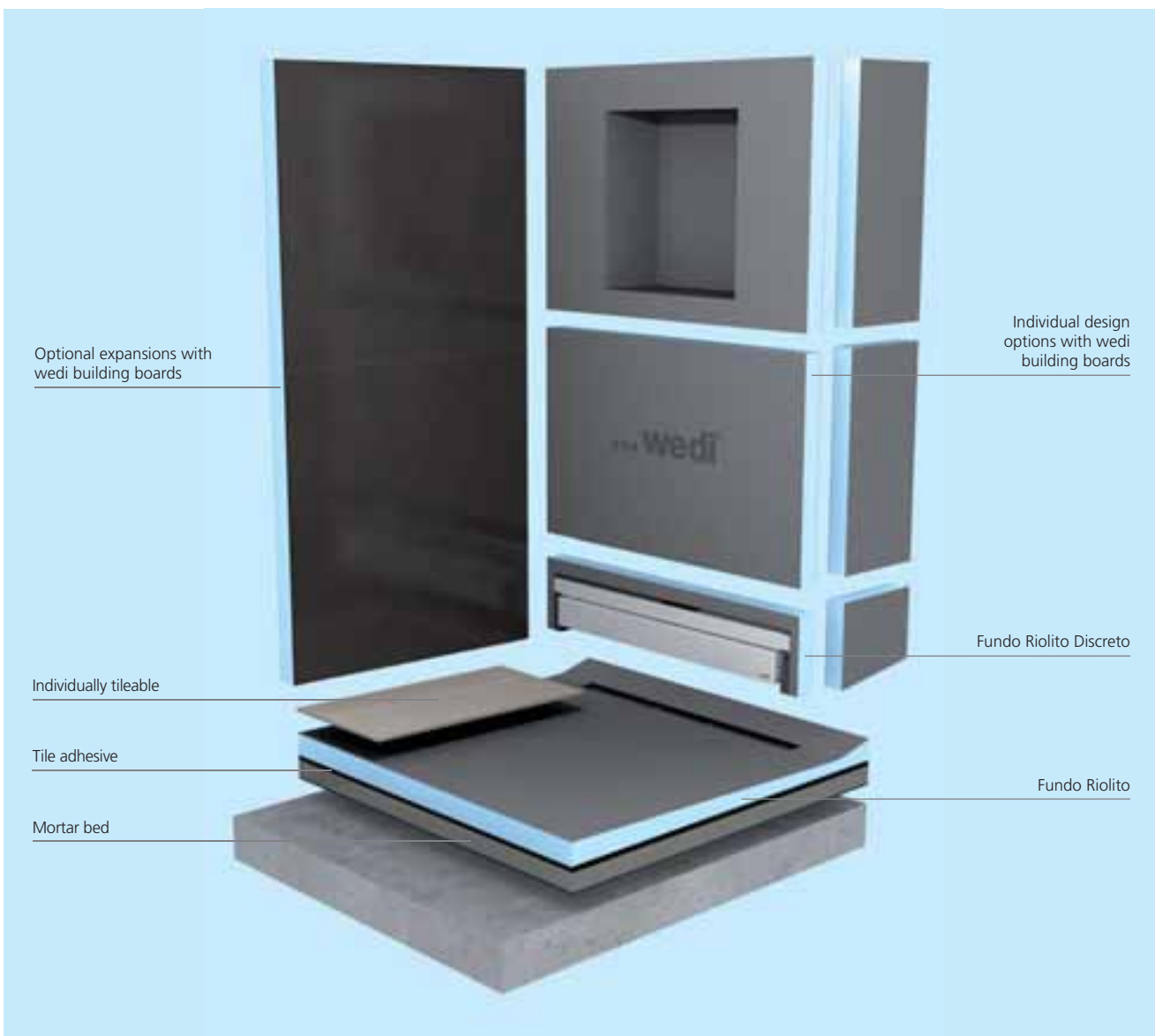

Optional expansions with wedi building boards

Individual design options with wedi building boards

Individually tileable

Fundo Riolito Discreto

Tile adhesive

Fundo Riolito

Mortar bed



wedi Fundo *Riolito Discreto* and the right system components

+ wedi 610

As a versatile single-component adhesive and sealant, wedi 610 is particularly well suited to creating a waterproof joint between wedi components. The combination of wedi building board and wedi 610 has an abP general appraisal certificate for the heavy-duty area.



+ wedi Fundo *Plano Linea* or Fundo *Riolito/Riolito^{neo}*

The flush-to-floor shower elements are especially impressive due to their excellent linear drainage. The required precise slope has already been shaped into the floor elements. The drain is also completely integrated with the Fundo Plano Linea.

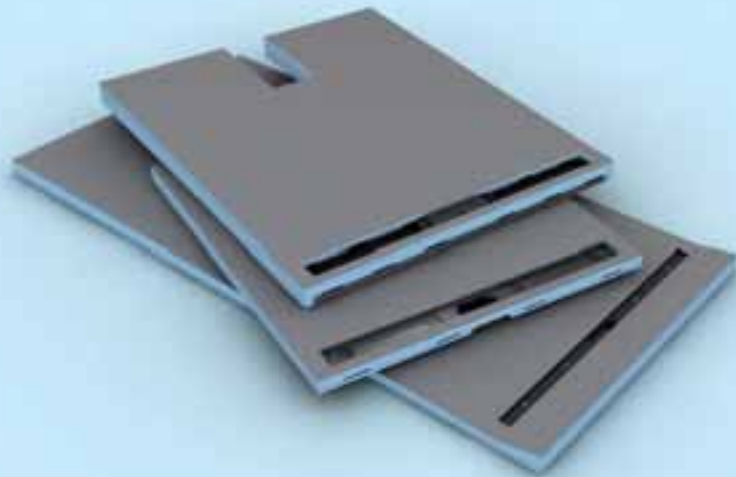

+ wedi Fundo sealing set

The sealing set to create a waterproof connection between wedi Fundo and wedi building boards or other materials not belonging to the system, e.g. screed, plasterboard, etc.



Drain versions Special solutions

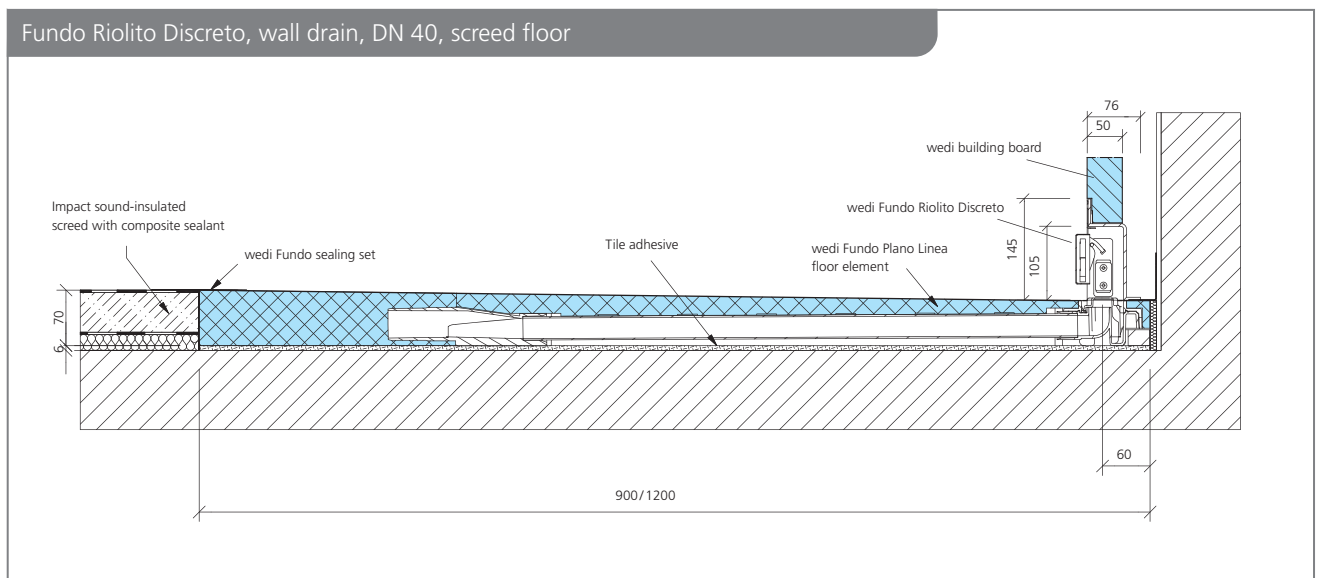
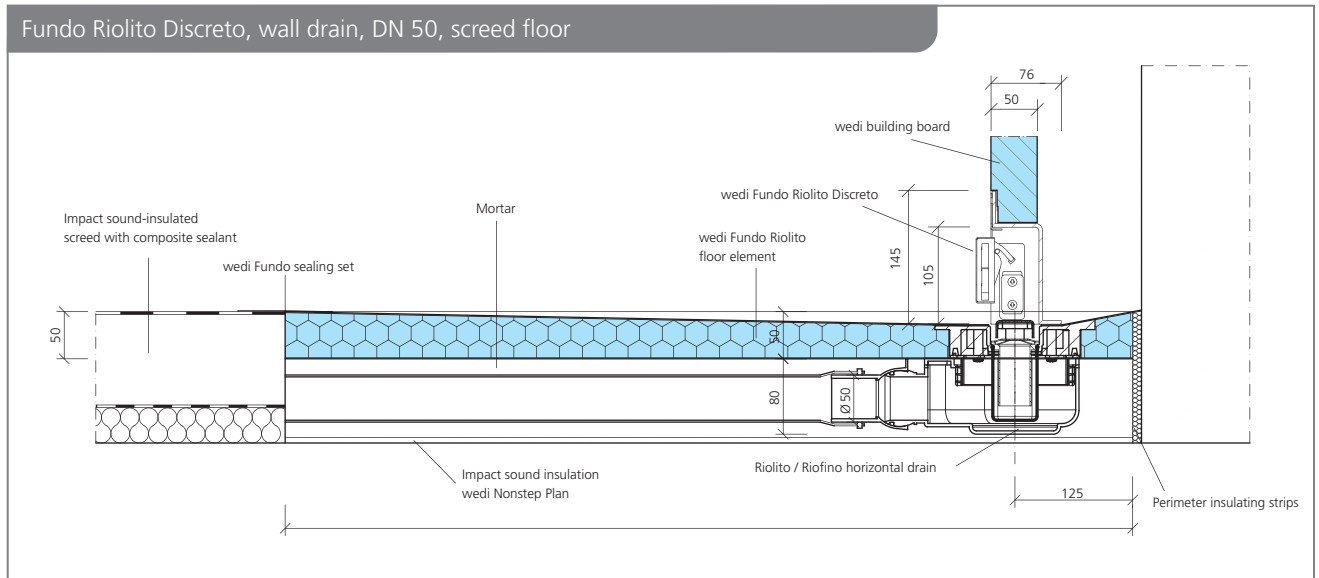

From the bench solution ...



... to individual storage options ...



... to the complete false wall!



i You will find further technical drawings in the relevant assembly instructions and in the "Creation of flush-to-floor showers" brochure.

Item numbers and designs

1st selection: Attachment element

	Length x height x depth	Packaging unit	Order no.
wedi Fundo Riolito Discreto, attachment element	800 x 180 x 76 mm ①	1 unit	07-37-38/200
wedi Fundo Riolito Discreto, attachment element	900 x 180 x 76 mm ②	1 unit	07-37-38/201
wedi Fundo Riolito Discreto, attachment element	1000 x 180 x 76 mm ③	1 unit	07-37-38/202

i The numbers ①, ② and ③ show the correct combination alternatives with the Fundo Riolito, Fundo Riolito^{neo}, Fundo Plano Linea floor elements.

2nd selection: Floor element

	Length x width x thickness	Gutter length	Order no.
wedi Fundo Riolito ^{neo} , floor element with channel, rectangular	1200 x 800 x 50 mm	700 mm ①	07-51-00/001
wedi Fundo Riolito ^{neo} , floor element with channel, rectangular	1200 x 900 x 50 mm	800 mm ②	07-51-00/004
wedi Fundo Riolito ^{neo} , floor element with channel, rectangular	1400 x 900 x 50 mm	700 mm ①	07-51-00/033
wedi Fundo Riolito ^{neo} , floor element with channel, rectangular	1800 x 900 x 60 mm	800 mm ②	07-51-00/005
wedi Fundo Riolito ^{neo} , floor element with channel, rectangular	1200 x 1000 x 50 mm	900 mm ③	07-51-00/008
wedi Fundo Riolito ^{neo} , floor element with channel, rectangular	1600 x 1000 x 50 mm	800 mm ②	07-51-00/034
wedi Fundo Riolito ^{neo} , floor element with channel, square	900 x 900 x 50 mm	800 mm ②	07-51-00/003
wedi Fundo Riolito ^{neo} , floor element with channel, square	1000 x 1000 x 50 mm	800 mm ②	07-51-00/032
wedi Fundo Riolito, floor element with channel, rectangular	1200 x 800 x 50 mm	700 mm ①	07-37-34/351
wedi Fundo Riolito, floor element with channel, rectangular	1200 x 900 x 50 mm	800 mm ②	07-37-34/356
wedi Fundo Riolito, floor element with channel, rectangular	1400 x 900 x 50 mm	700 mm ①	07-37-34/361
wedi Fundo Riolito, floor element with channel, rectangular	1800 x 900 x 60 mm	800 mm ②	07-37-34/358
wedi Fundo Riolito, floor element with channel, rectangular	1200 x 1000 x 50 mm	900 mm ③	07-37-34/352
wedi Fundo Riolito, floor element with channel, rectangular	1600 x 1000 x 50 mm	800 mm ②	07-37-34/362
wedi Fundo Riolito, floor element with channel, square	900 x 900 x 50 mm	800 mm ②	07-37-34/354
wedi Fundo Riolito, floor element with channel, square	1000 x 1000 x 50 mm	800 mm ②	07-37-34/360
wedi Fundo Plano Linea, floor element with channel and fully integrated drain technology, rectangular	1200 x 800 x 70 mm	700 mm ①	07-37-36/600
wedi Fundo Plano Linea, floor element with channel and fully integrated drain technology, rectangular	1200 x 900 x 70 mm	800 mm ②	07-37-36/601
wedi Fundo Plano Linea, floor element with channel and fully integrated drain technology, rectangular	1200 x 1000 x 70 mm	900 mm ③	07-37-36/602
wedi Fundo Plano Linea, floor element with channel and fully integrated drain technology, square	900 x 900 x 70 mm	800 mm ②	07-37-36/603

3rd selection: Sealant

	Quantity / length x width	Packaging unit	Order no.
Version 1 – Installation in screed; no wall/floor connection with wedi building board			
wedi Fundo sealing set		1 pail	07-37-96/000
wedi Tools, sealing tape, fleece-lined	50 m x 100 mm	1 roll	09-51-00/352
wedi Tools, sealing tape, fleece-lined	10 m x 120 mm	1 roll	09-51-10/311
wedi Tools, sealing tape, fleece-lined	50 m x 120 mm	1 roll	09-51-10/352
wedi Tools, inside corners, fleece laminated	120 x 120 mm	25 units	09-51-30/001
wedi Tools, outside corners, fleece laminated	115 x 115 mm	25 units	09-51-35/001
Version 2 – Installation on the floor; connection to wall/floor with wedi building board			
wedi 610, adhesive sealant	310 ml / 1 cartridge	20 units	07-69-02/002
wedi Tools, joint reinforcement tape	25 m x 125 mm	1 roll	09-52-20/053
wedi Tools, joint reinforcement tape, self-adhesive	25 m x 125 mm	1 roll	09-52-25/053



You can find countless expansion options for your shower or complete bathroom conversion in the wedi product range.



All installation instructions can be found using this QR code.





wedi Fundo fire protection collar

Small part, big effect. The perfect fire prevention measure for all Fundo designs

Effective fire prevention is a must, especially in apartment buildings, public buildings and commercial properties. With the wedi fire protection collar for all Fundo vertical drains, buildings can be easily, safely and sustainably protected.

Item numbers and designs

	Packaging unit	Order no.
wedi fire protection collar for Fundo vertical drain, DN 50	1 unit	07-37-49/002
wedi fire protection collar for Fundo Riolito / Riofino, vertical drain, DN 50	1 unit	07-37-89/012



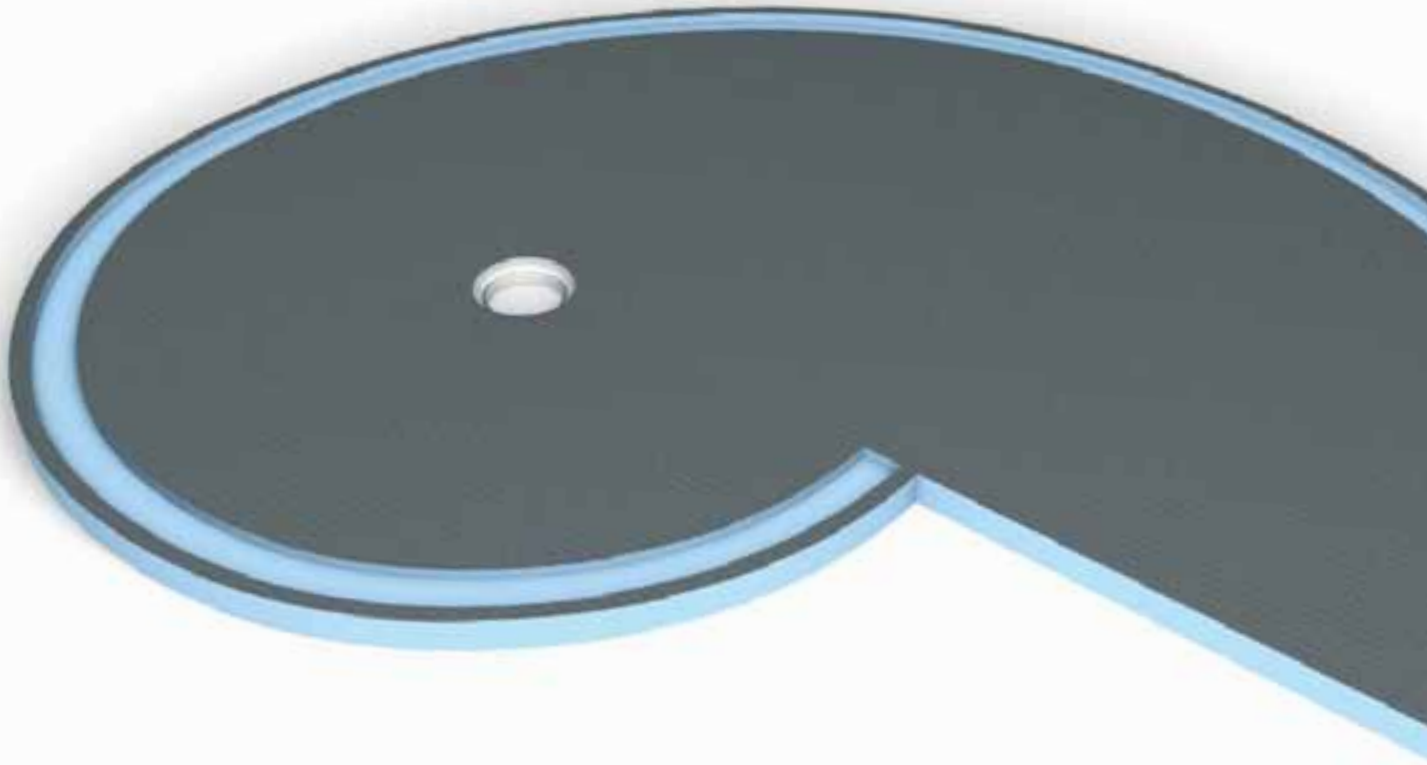

wedi Fundo *Nautilo*

Flush-to-floor shower element
in a distinct shell shape

Flush-to-floor showers are virtually essential nowadays, especially in public spa facilities, as they combine a high quality appearance with a high degree of functionality. The wedi Fundo design concept combines creative lines with natural forms, and also offers the right wall elements for the Fundo Trollo and Nautilo floor elements – with or without the supply channels.



True-to-size wall
elements available



Exactly uniform
predefined gradient



Particularly stable
surfaces

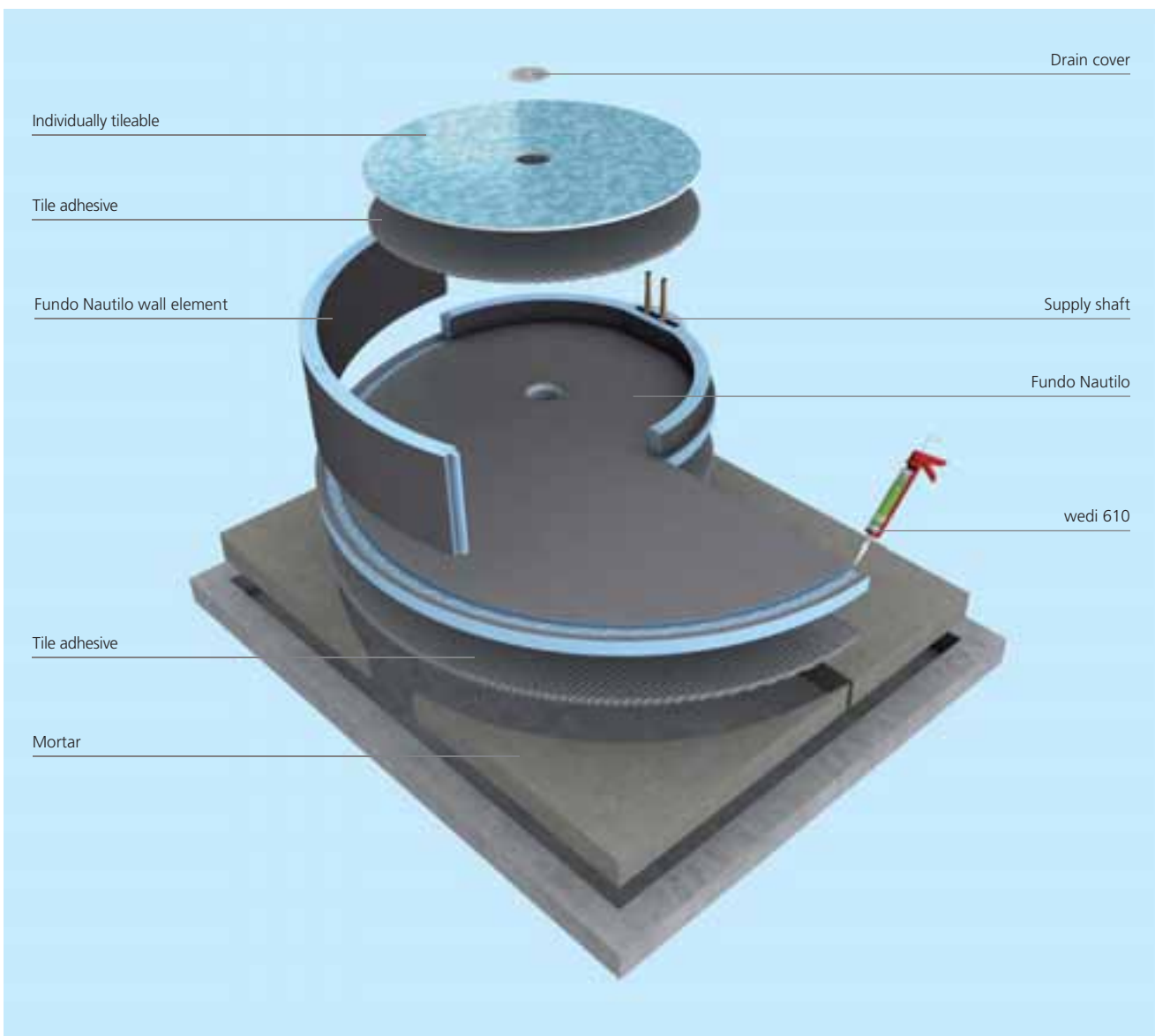

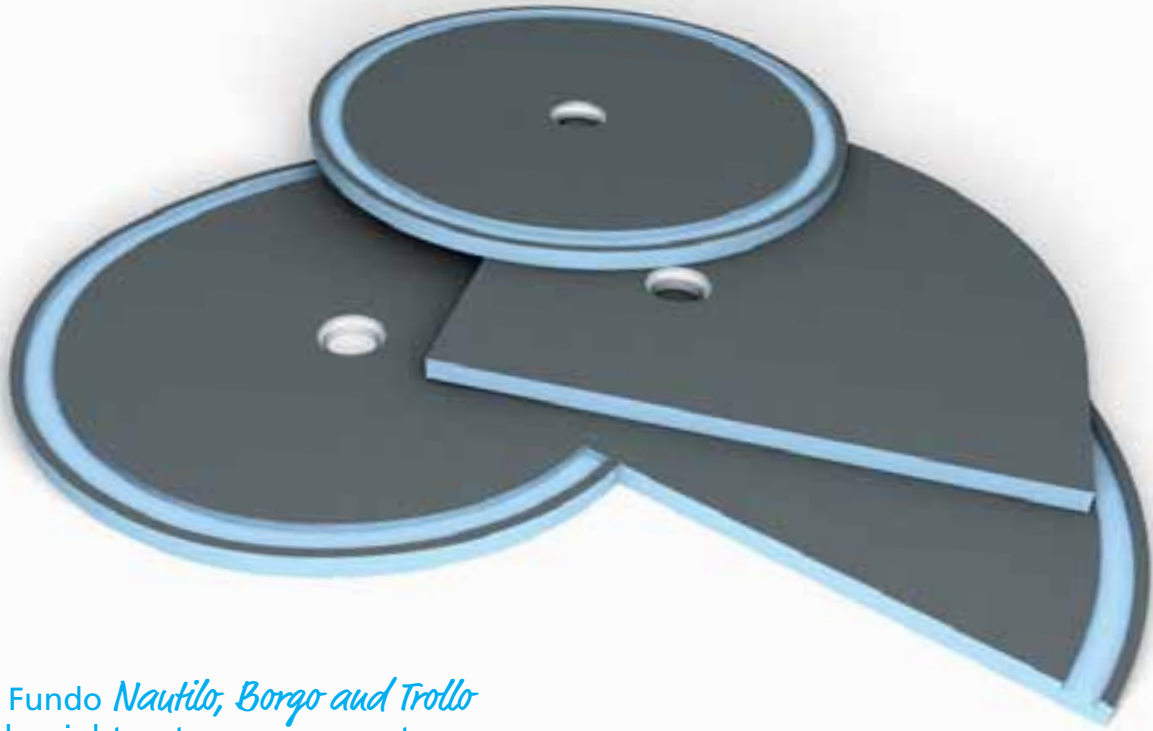

wedi Fundo *Nautilo, Borgo and Trollo* and the right system components

+ wedi Fundo drain

Thanks to the low installation height and waterproof security, the wedi drains are very well suited to new builds and renovations. There is a variety of different versions for vertical and horizontal designs.



+ wedi Fundo sealing set

The sealing set to create a waterproof connection between wedi Fundo and wedi building boards or other materials not belonging to the system, e.g. screed, plasterboard, etc.



+ wedi *Tools* joint reinforcement tape

Special (self-adhesive) glass fibre mesh tape to fix and bridge the protruding edges of structural panels.



+ wedi 610

As a versatile single-component adhesive and sealant, wedi 610 is particularly well suited to creating a waterproof joint between wedi components. The combination of wedi building board and wedi 610 has an abP general appraisal certificate for the heavy-duty area.



Drain versions Point drainage

Fundo horizontal drain, DN 50, screed flooring

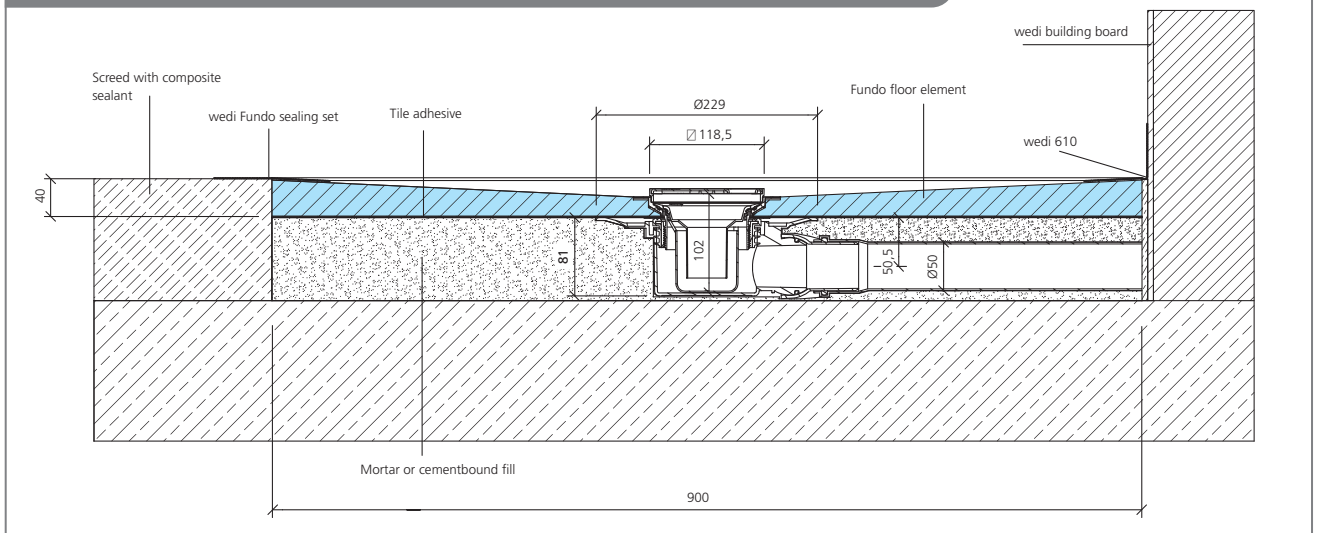

Fundo vertical drain, DN 50, screed flooring (also available with fire breakpoint and DN 70)

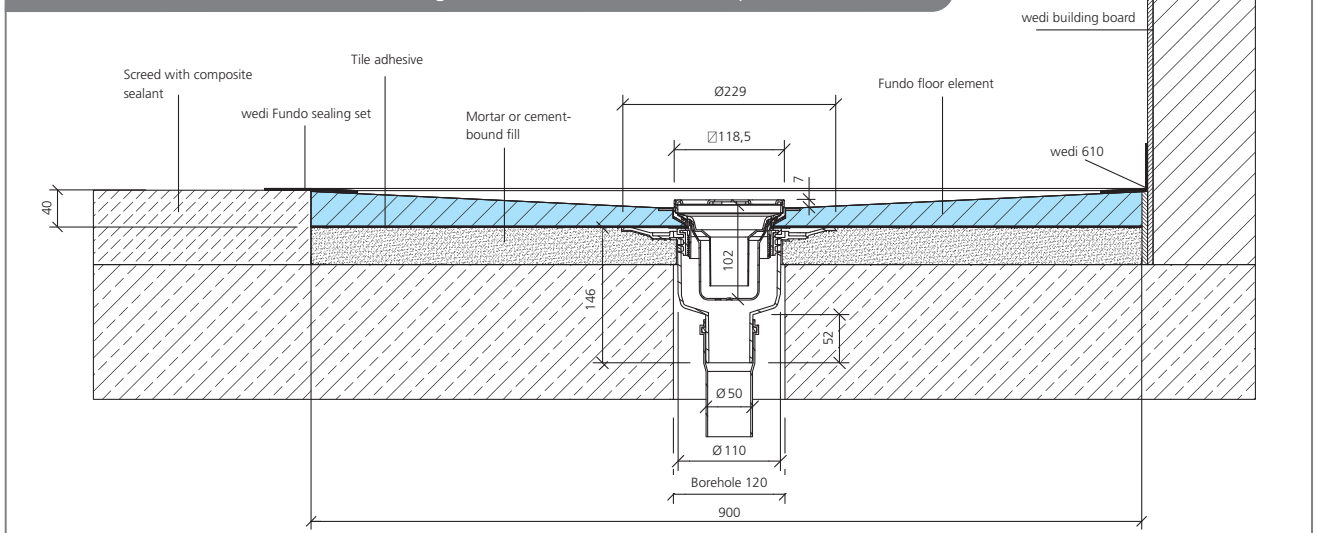

Fundo drain Mini Max drain, DN 40

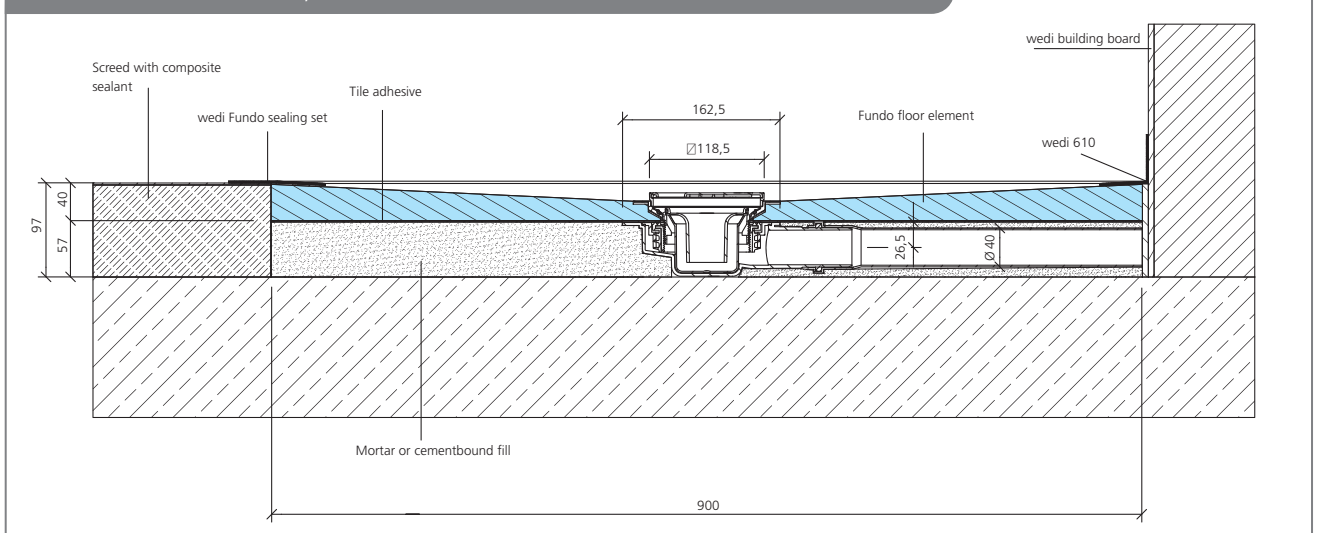

i You will find further technical drawings in the relevant assembly instructions and in the "Creation of flush-to-floor showers" brochure.

Item numbers and designs

1st selection: Floor element

	Length x width x thickness	Packaging unit	Order no.
wedi Fundo Nautilo, right entry	1890 x 1515 x 50 mm	10 units	07-37-36/066
wedi Fundo Nautilo, left entry	1890 x 1515 x 50 mm	10 units	07-37-36/065
wedi Fundo Borgo, offset drain	900 x 900 x 40 mm	10 units	07-37-35/576
wedi Fundo Borgo, offset drain	1000 x 1000 x 40 mm	10 units	07-37-36/576
wedi Fundo Trollo, central drain	Ø 1140 x 40 mm	10 units	07-37-36/575

2nd selection: Wall element

	Height	Packaging unit	Order no.
wedi Fundo Nautilo, wall element	2015 mm	1 unit	04-17-08/000
wedi Fundo Nautilo, extension collar	500 mm	1 unit	04-17-08/052
wedi Fundo Nautilo ^{libero} , wall element	2050 mm	1 unit	04-17-08/002
wedi Fundo Nautilo ^{libero} , extension collar	500 mm	1 unit	04-17-08/053
wedi Fundo Trollo, wall element	2015 mm	1 unit	04-17-09/002
wedi Fundo Trollo, extension collar	500 mm	1 unit	04-17-09/052
wedi Fundo Trollo ^{libero} , wall element	2015 mm	1 unit	04-17-09/003
wedi Fundo Trollo ^{libero} , extension collar	500 mm	1 unit	04-17-09/053

3rd selection: Drain

	Packaging unit	Order no.
wedi Fundo vertical drain, DN 50, square, drainage capacity 1.00 l/s ; 60.0 l/min	1 unit	07-70-00/007
wedi Fundo vertical drain, DN 50, round, drainage capacity 1.00 l/s ; 60.0 l/min	1 unit	07-70-00/008
wedi Fundo vertical drain, DN 50, with fire protection collar, drainage capacity 1.00 l/s ; 60.0 l/min	1 unit	07-37-49/002
wedi Fundo vertical drain, DN 70, drainage capacity 0.88 l/s ; 52.8 l/min	1 unit	07-70-00/010
wedi Fundo horizontal drain, DN 50, square, drainage capacity 0.80 l/s ; 48.0 l/min	1 unit	07-70-00/011
wedi Fundo horizontal drain, DN 50, round, drainage capacity 0.80 l/s ; 48.0 l/min	1 unit	07-70-00/012
wedi Fundo drain Mini Max, DN 40, extra-flat, drainage capacity 0.54 l/s ; 32.4 l/min	1 unit	07-70-00/015

4th selection: Sealant

	Quantity / length x width	Packaging unit	Order no.
Version 1 – Installation in screed; no wall/floor connection with wedi building board			
wedi Fundo sealing set		1 pail	07-37-96/000
wedi Tools, sealing tape, fleece-lined	50 m x 100 mm	1 roll	09-51-00/352
wedi Tools, sealing tape, fleece-lined	10 m x 120 mm	1 roll	09-51-10/311
wedi Tools, sealing tape, fleece-lined	50 m x 120 mm	1 roll	09-51-10/352
wedi Tools, inside corners, fleece laminated	120 x 120 mm	25 units	09-51-30/001
wedi Tools, outside corners, fleece laminated	115 x 115 mm	25 units	09-51-35/001
Version 2 – Installation on the floor; connection to wall/floor with wedi building board			
wedi 610, adhesive sealant	310 ml / 1 cartridge	20 units	07-69-02/002
wedi Tools, joint reinforcement tape	25 m x 125 mm	1 roll	09-52-20/053
wedi Tools, joint reinforcement tape, self-adhesive	25 m x 125 mm	1 roll	09-52-25/053



You can find countless expansion options for your shower or complete bathroom conversion in the wedi product range.



All installation instructions can be found using this QR code.

wedi Fundo Special floor elements

wedi Fundo Primo

wedi Fundo Primo, square, rectangular, one piece

Length X: max. 2400 mm
 Width Y: max. 1500 mm
 Thickness: 40 mm + 50 mm

Dimensions
 YA = min. 200 mm
 XA = min. 200 mm

07-37-14/099

i 4 – 6 weeks after final technical clearance and release of order.
 (Only applies to orders of 1 to 3 units; larger numbers of units require an individual check).

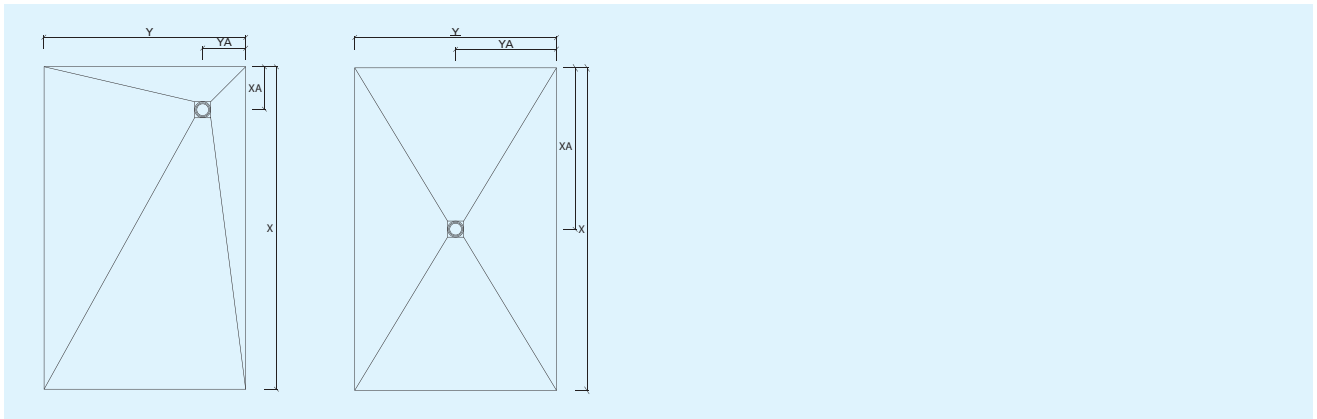

wedi Fundo Riolito^{neo}

wedi Fundo Riolito^{neo}, square, rectangular, one piece
 1-sided slope:

Length X: max. 1600 mm
 Width Y: max. 1500 mm
 Thickness: 50 mm

Dimensions YA =
 min. 30 mm,
 max. 300 mm

07-37-16/199

wedi Fundo Riolito^{neo}, square, rectangular, one piece
 2-sided slope:

Length X: max. 1650 mm
 Width Y: max. 1500 mm
 Thickness: 50 mm

Dimensions YA =
 min. 30 mm,
 max. 300 mm

07-37-16/199

wedi Fundo Riolito^{neo}, square, rectangular, one piece
 4-sided slope:

Length X: max. 1800 mm
 Width Y: max. 1500 mm
 Thickness: 50 mm

Dimensions
 YA = min. 200 mm
 ZA = min. 200 mm

07-37-16/199

i 4 – 6 weeks after final technical clearance and release of order.
 (Only applies to orders of 1 to 3 units; larger numbers of units require an individual check).

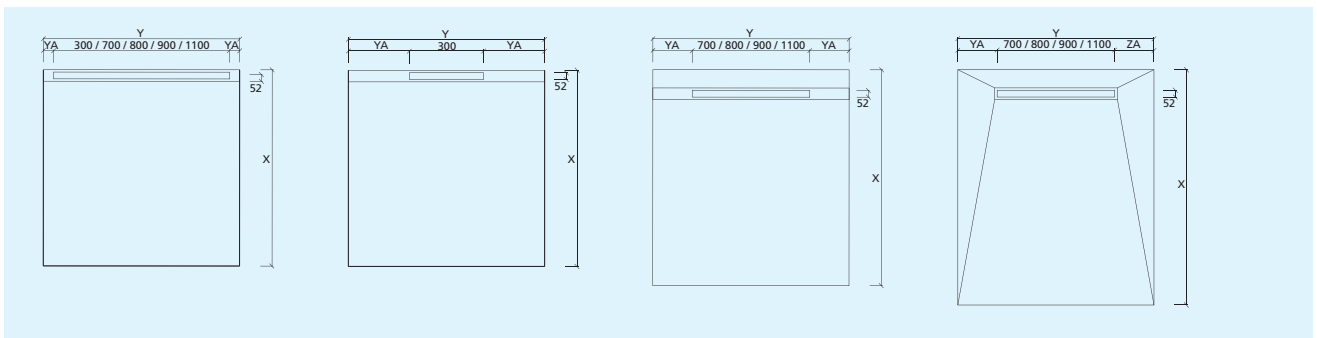

wedi Fundo Riolito

wedi Fundo Riolito, square, rectangular, one piece
2-sided slope:

Length X: max. 1650 mm
Width Y: max. 1500 mm
Thickness: 50 mm

Dimensions YA =
min. 30 mm,
max. 300 mm

07-37-14/199

wedi Fundo Riolito, square, rectangular, one piece
4-sided slope:

Length X: max. 1800 mm
Width Y: max. 1500 mm
Thickness: 50 mm

Dimensions
YA = min. 200 mm
ZA = min. 200 mm

07-37-14/199

i 4 – 6 weeks after final technical clearance and release of order.

(Only applies to orders of 1 to 3 units; larger numbers of units require an individual check).

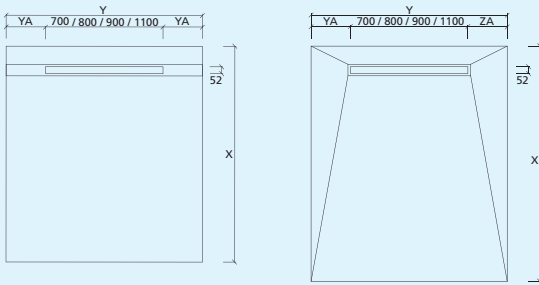

wedi Fundo Riofino

wedi Fundo Riofino, square, rectangular, one piece
with Riolito^{neo} or Riolito drain system

Length X: max. 1800 mm
Width Y: max. 1500 mm
Thickness: 50 mm

Dimensions
YA = min. 200 mm
XA = min. 200 mm

Fundo Riolito^{neo} drain system

07-37-16/299

Fundo Riolito drain system

07-37-14/299

i 4 – 6 weeks after final technical clearance and release of order.

(Only applies to orders of 1 to 3 units; larger numbers of units require an individual check).

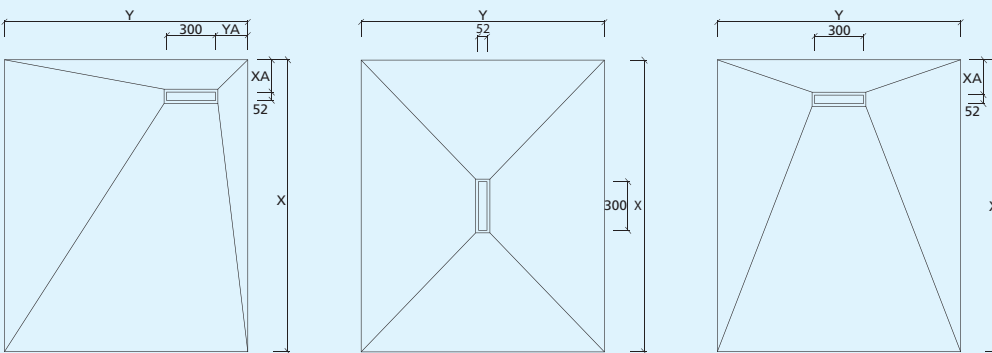

wedi Fundo substrate element

wedi Fundo substrate element, square, rectangular, one piece

Length X: max. 2400 mm

Width Y: max. 1500 mm

Thickness: 60 – 120 mm

07-37-14/399

i 4 – 6 weeks after final technical clearance and release of order.

(Only applies to orders of 1 to 3 units; larger numbers of units require an individual check).

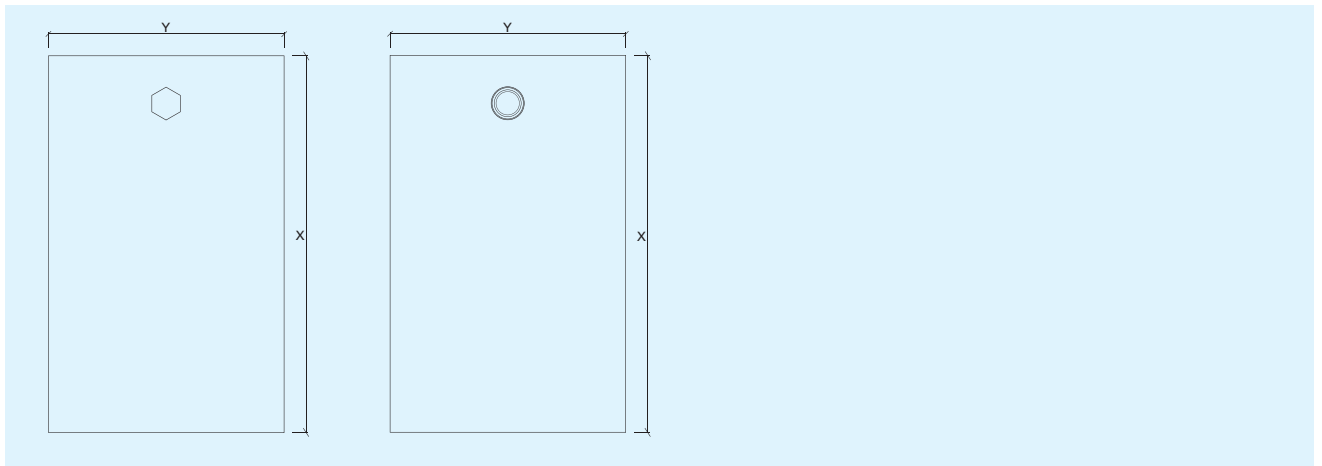

wedi Fundo Individual

wedi Fundo Individual,
multi-corner; round; multi-piece; individual
dimensions, design and thickness

Length X: individual

Width Y: individual

Thickness: individual

07-37-14/499

i Manual check, 4 – 6 weeks after final technical clearance and release of order.

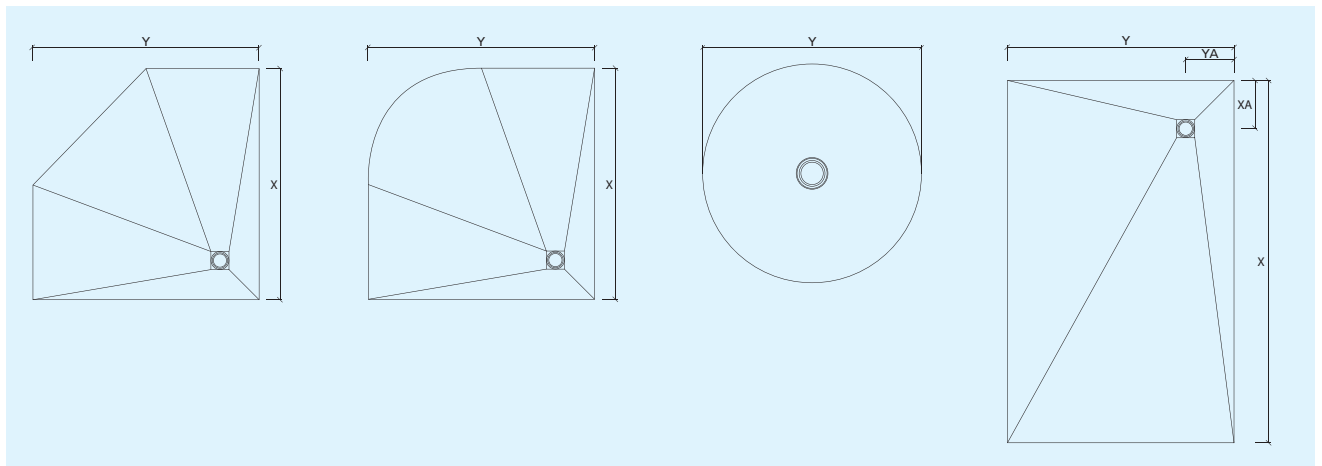

wedi Fundo Riolito^{neo} / Riofino Individual

wedi Fundo Riolito^{neo} / Riofino Individual,
Individual, hot water heating possible

Length X: individual
Width Y: individual
Thickness: individual

07-37-16/599

- i** 4 – 6 weeks after final technical clearance and release of order.
(Only applies to orders of 1 to 3 units; larger numbers of units require an individual check).

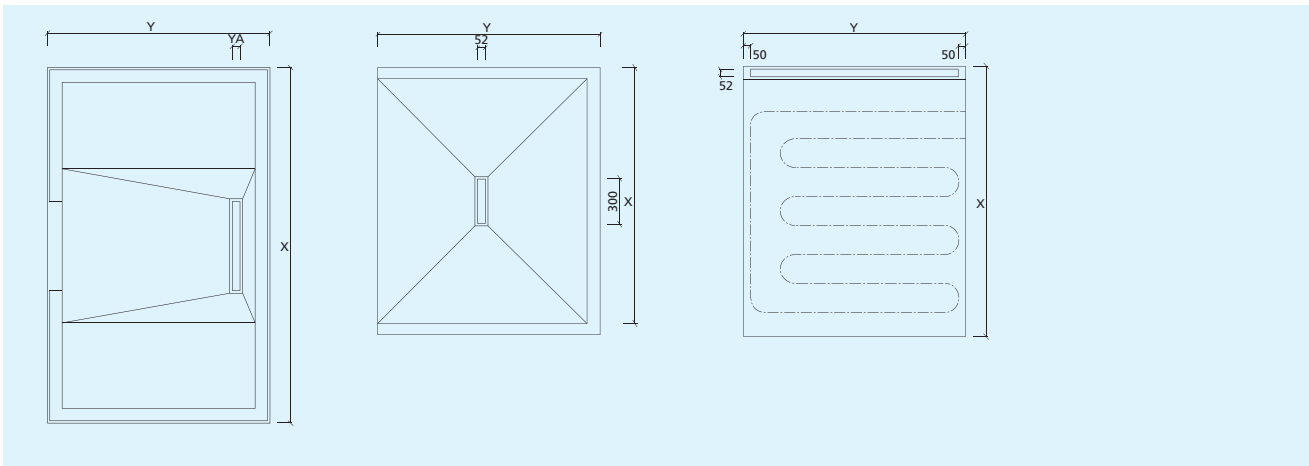

wedi Fundo Riolito / Riofino Individual

wedi Fundo Riolito / Riofino Individual,
Individual, WWH possible

Length X: individual
Width Y: individual
Thickness: individual

07-37-14/599

- i** Manual check, 4 – 6 weeks after final technical clearance and release of order.

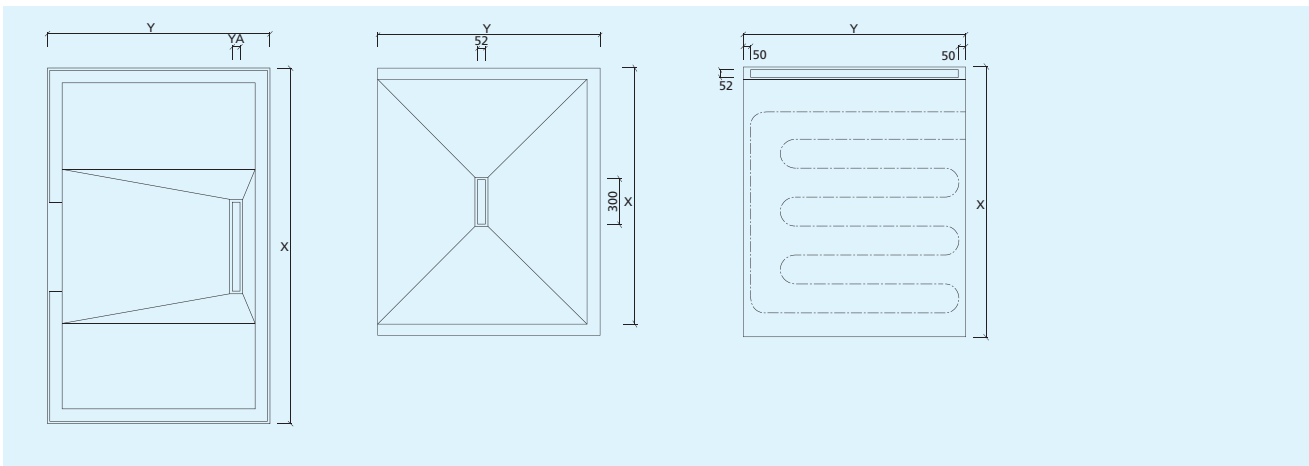

wedi Fundo Plano

wedi Fundo Plano, square, rectangular, one piece

Length X: min. 800 mm/max. 1600 mm
 Width Y: min. 800 mm/max. 1500 mm
 Thickness: 65 mm

Slope section YA: min. 260 mm/max. 900 mm
 Slope section YB: min. 260 mm/max. 900 mm
 Slope section XA: min. 260 mm/max. 900 mm
 Slope section XB: min. 450 mm/max. 600 mm

07-37-14/699

i 4 – 6 weeks after final technical clearance and release of order.
 (Only applies to orders of 1 to 3 units; larger numbers of units require an individual check).

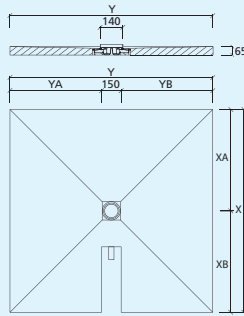

wedi Fundo Ligno Individual

Fundo Ligno Individual, square, rectangular, one piece, centred, central drain

Length X: min. 800 mm/max. 1600 mm
 Length Y: min. 800 mm/max. 1550 mm

07-37-14/799

Fundo Ligno Individual, square, rectangular, one piece, off-centred, close to the wall, Drain point 260 x 260 mm off the edge

Length X: min. 800 mm/max. 1260 mm
 Length Y: min. 800 mm/max. 1260 mm

07-37-14/799

Fundo Ligno Individual, square, rectangular, one piece, off-centered, variable, Variable drain point but the dimension of the drain axis (XA, YA) must not be less than 260 mm or more than 1000 mm off the edge!

Length X: min. 800 mm/max. 1600 mm
 Length Y: min. 800 mm/max. 1550 mm

07-37-14/799

i 4 – 6 weeks after final technical clearance and release of order.
 (Only applies to orders of 1 to 3 units; larger numbers of units require an individual check).

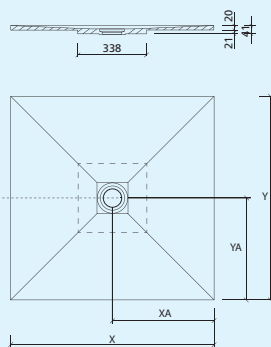

Turning

Besides the countless Fundo floor systems and the system components required to install these, wedi also offers a variety of creative design options for your whole bathroom.

Please turn the brochure by 180 degrees and leaf through it from back to front. Let us also turn your bathroom literally "upside down".

point

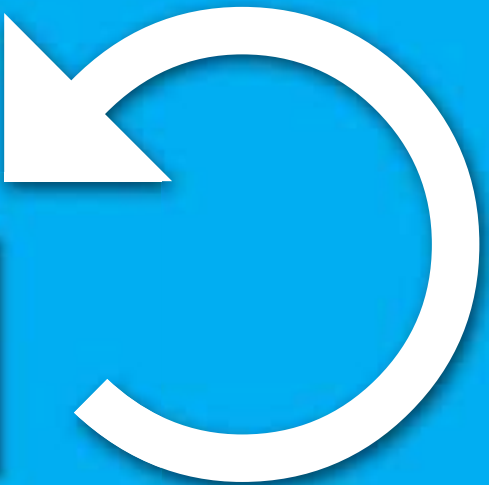

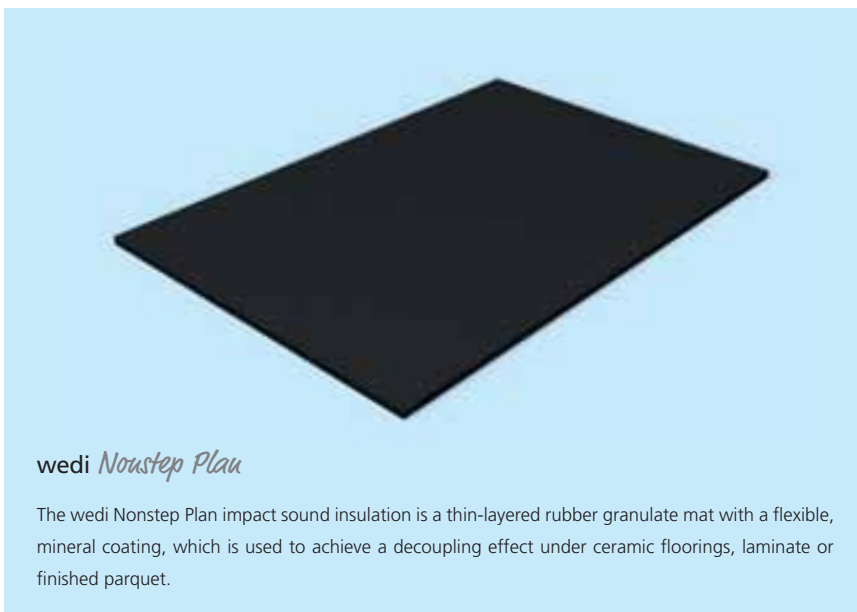

wedi *Nonstep Plus*

The wedi Nonstep Plus impact sound insulation is a 6 mm wedi building board, which is joined to a 5 mm rubber mat during manufacture so that a shiplap joint is created. The impact sound insulating panel is used to create a decoupling effect under ceramic flooring, laminate and finished parquet. This thin-layered impact insulation particularly shows its strength in 2-storey houses, public buildings and apartment blocks.

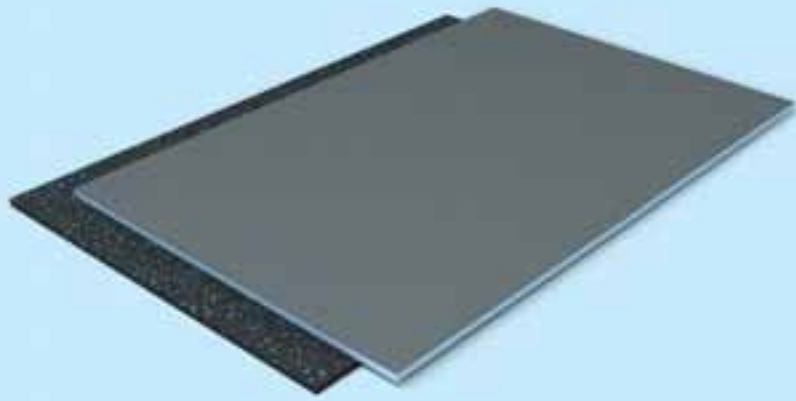

IMPACT SOUND INSULATION



wedi Fundo *Primo Easy Set*

With this simple complete set, flush-to-floor wedi Fundo Primo and Ligno showers can be quickly and easily adjusted to the right height – without any laborious filling with mortar and screed. Be it a platform solution or classic lining, the total installation height of the Fundo Primo Easy Set plus Fundo floor element is 14 cm.

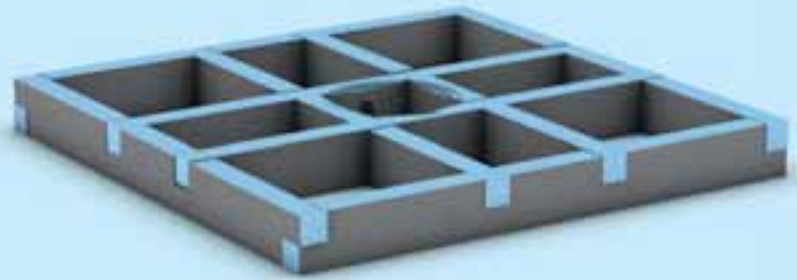

SUBSTRUCTURES



wedi Fundo *Ligno* drain substructure element

The Fundo Ligno drain substructure element is designed especially for use with the Fundo Ligno in timber joist floors.

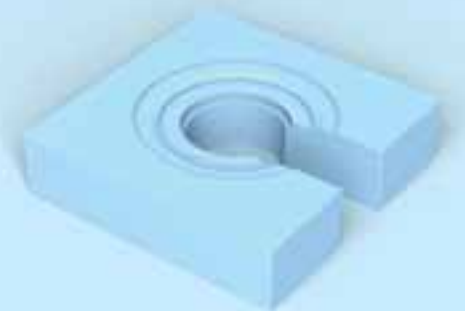



DRAIN COVERS



wedi Fundo *Fino*

wedi offers a multitude of covers especially for the Fundo floor elements – from classic to modern to covers made of solid stainless steel.



WALL DRAIN

wedi Fundo *Riolito Discreto*

The absolutely innovative Fundo Riolito Discreto literally tops the tried and tested Riolito. As a simple fixture, this clever innovation creates the illusion of a wall drain. The fixture can be incorporated in all wet room scenarios. Whether as a seat, shelf or a complete false wall – there are no limits to the design ideas with these system components.

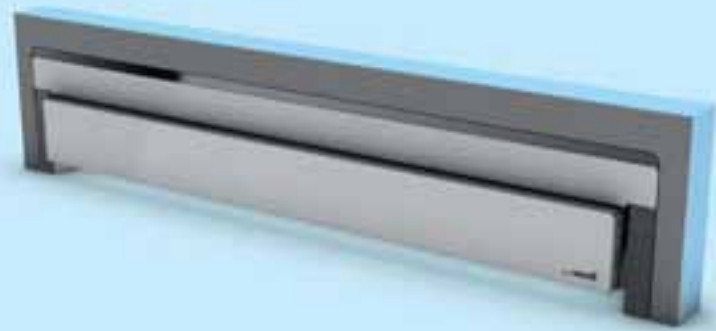



END PROFILES

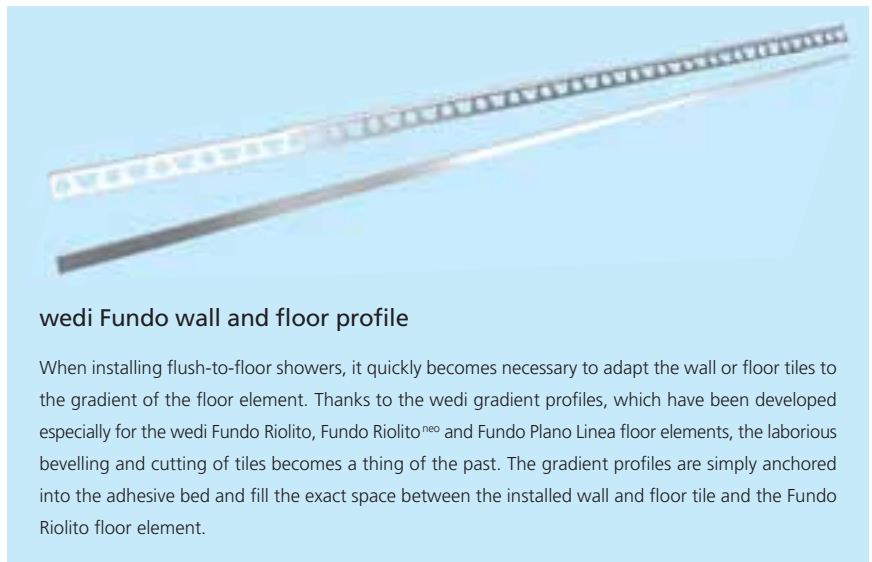

wedi Fundo wall and floor profile

When installing flush-to-floor showers, it quickly becomes necessary to adapt the wall or floor tiles to the gradient of the floor element. Thanks to the wedi gradient profiles, which have been developed especially for the wedi Fundo Riolito, Fundo Riolito^{neo} and Fundo Plano Linea floor elements, the laborious bevelling and cutting of tiles becomes a thing of the past. The gradient profiles are simply anchored into the adhesive bed and fill the exact space between the installed wall and floor tile and the Fundo Riolito floor element.



SHELVES & STORAGE

wedi *Meusolo-L & -U*

Even in showers, shelving and niche solutions are extremely popular and also very practical. As well as the extra space for implements of all kinds, you can place a slight emphasis using design and lighting.

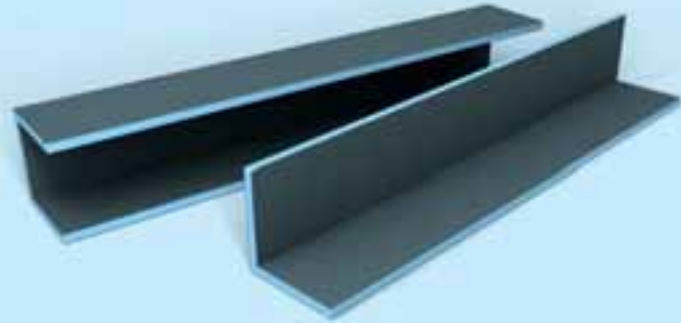



SEATING SOLUTIONS

wedi Sanoasa *Bellina*

The Sanoasa benches are available in so many different designs that you can build virtually any combination of seating. Whether it's straight or curved benches, they will be the highlight in any bathroom or spa facility by the time the tiling has been completed.

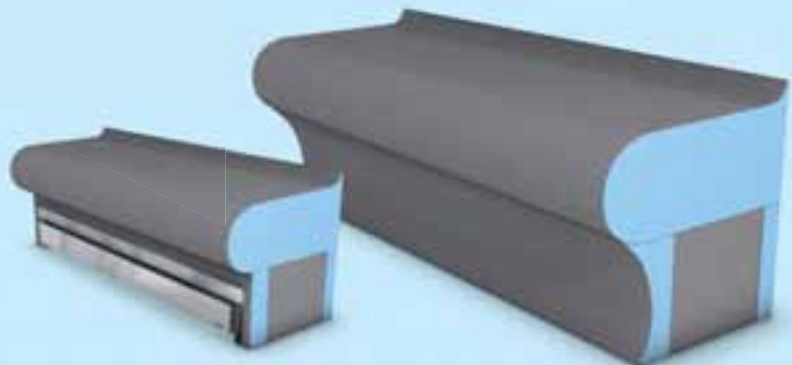



wedi Fundo *Nautilo* wall element

Extraordinary shower shapes in your own bathroom? But of course! wedi offers a variety of systems with floor and wall elements. Square, round or shell-shaped – always the right idea to suit any space and any taste.

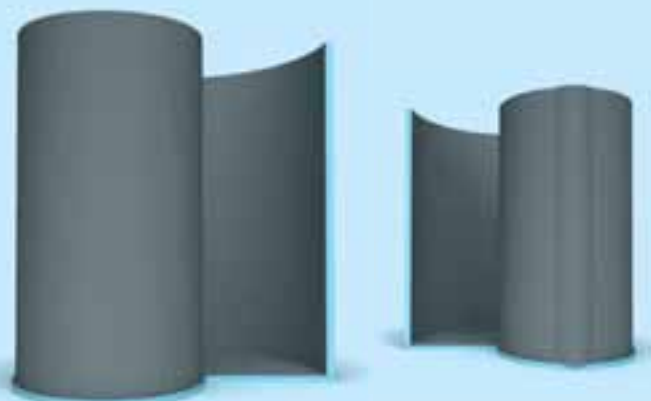



WALL ELEMENTS



wedi *Moltoromo*

With the modular wedi Moltoromo system, a variety of wall shapes can be sensationally created for different bathroom and spa uses. Round shapes, corner solutions and wavy lines are quick and easy to fit. There are no limits to the design with tiles, plaster and other finishes.





PARTITION WALLS



wedi building board *XL & XXL*

The large-scale building boards are particularly characterised by their extraordinary width of up to 1.20 metres, making them ideal for use as free-standing walls. The building board XL and XXL combine all the advantages of the classic wedi building board and are particularly light-weight and easy to use, despite their size.





© Jostba

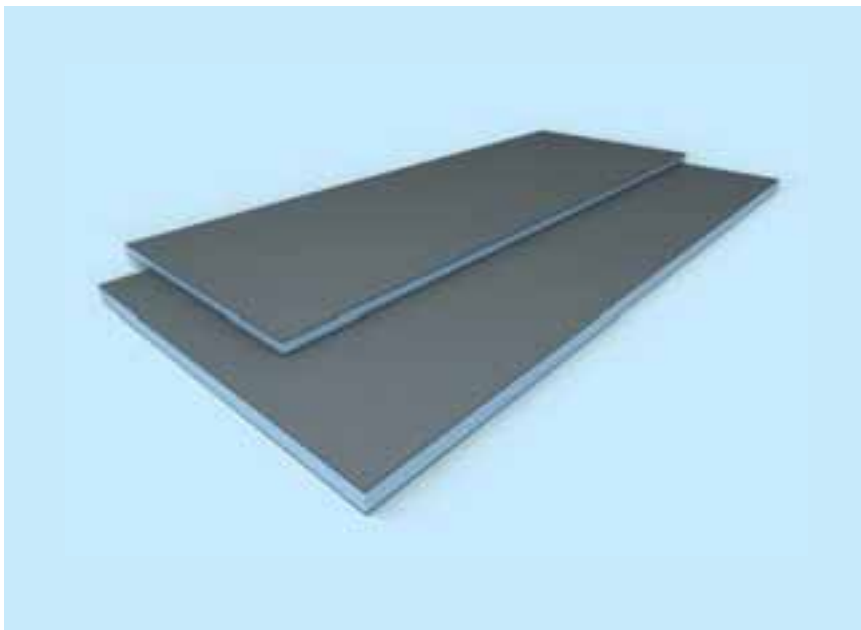

wedi building boards

The versatility of wedi building boards is unique. Whether a complete bathroom, individual washbasin, creative shower structure or special individual piece, ideas take shape with the building board from wedi. Without any loss of function or guarantee, these building boards can be tailored to any desired format and form, offering unbroken thermal insulation and waterproofness in one.







On offer from wedi INSIDE!

The principle of wedi INSIDE is very simple: high-quality ceramic coverings require an absolutely secure foundation. For this reason, tradesmen have relied on the unique wedi quality for decades, especially under tiles. 100 % watertight and that is absolutely certain – guaranteed by wedi!



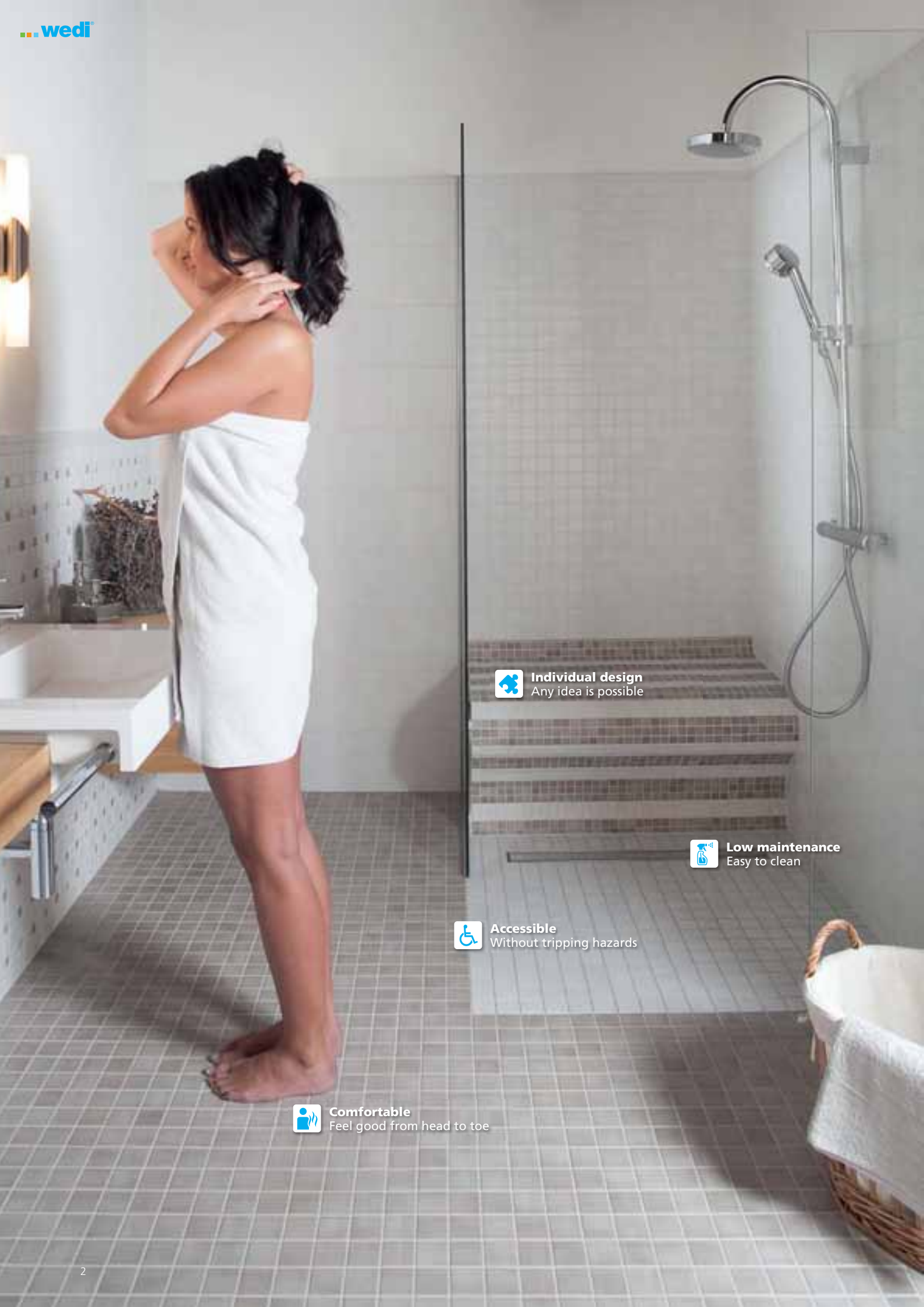





 **Individual design**
Any idea is possible

 **Low maintenance**
Easy to clean

 **Accessible**
Without tripping hazards

 **Comfortable**
Feel good from head to toe

Many questions, one answer: **wedi**

When renovating your bathroom and especially when selecting the right shower, there are some important questions that need answering. Does an accessible flush-to-floor shower make sense? Do you want a point or linear drainage system? Would a wall drain be attractive for you? Will the shower have a standard size or can it be custom-made? And last but not least, what accessories do you need and what are the options available for the implementation of design ideas?

In this documentation, you will find the answers to all the important questions as well as the certainty of having found the best possible overall solution for any requirement with wedi systems.



Comfortable

All Fundo floor elements are perfectly suited as an underlay for tiles. As well as individual design, they provide long-lasting warmth and a pleasant underfoot feeling when combined with tiles as the top covering.



Accessible

The flush-to-floor Fundo shower elements combine puristic design perfectly with a high functionality and allow young and old to enjoy limitless bathing enjoyment – without any tripping hazards or sharp corners.



Individual design

As they are flush to the floor, the Fundo series offers an enormous amount of design options: from optical enlargement of the bathroom with continuous tiling through to the individual design of your shower with extras, such as niches, storage and seating areas..



Low maintenance

One wipe and it's all clean. Because all Fundo floor elements are flush-to-floor, making the cleaning of the bathroom floor much simpler. Combined with tiled shower walls, e.g. using the wedi XL structural panel as a basis, cleaning the walls is also child's play..

A shower experience of a very special kind

Tileable, accessible and with a modular design

